

Teil A31

Teil A32

Teil A02  
(mit A03 + A04 + A05 + A06)  
ankleben

A01

50 mm

Teil E01  
ankleben

Blatt 01/23  
Papier 200 g/m<sup>2</sup> oder stärker

Teil A35

Teil A34

Georgen-Kirche  
Dessau-Roßlau



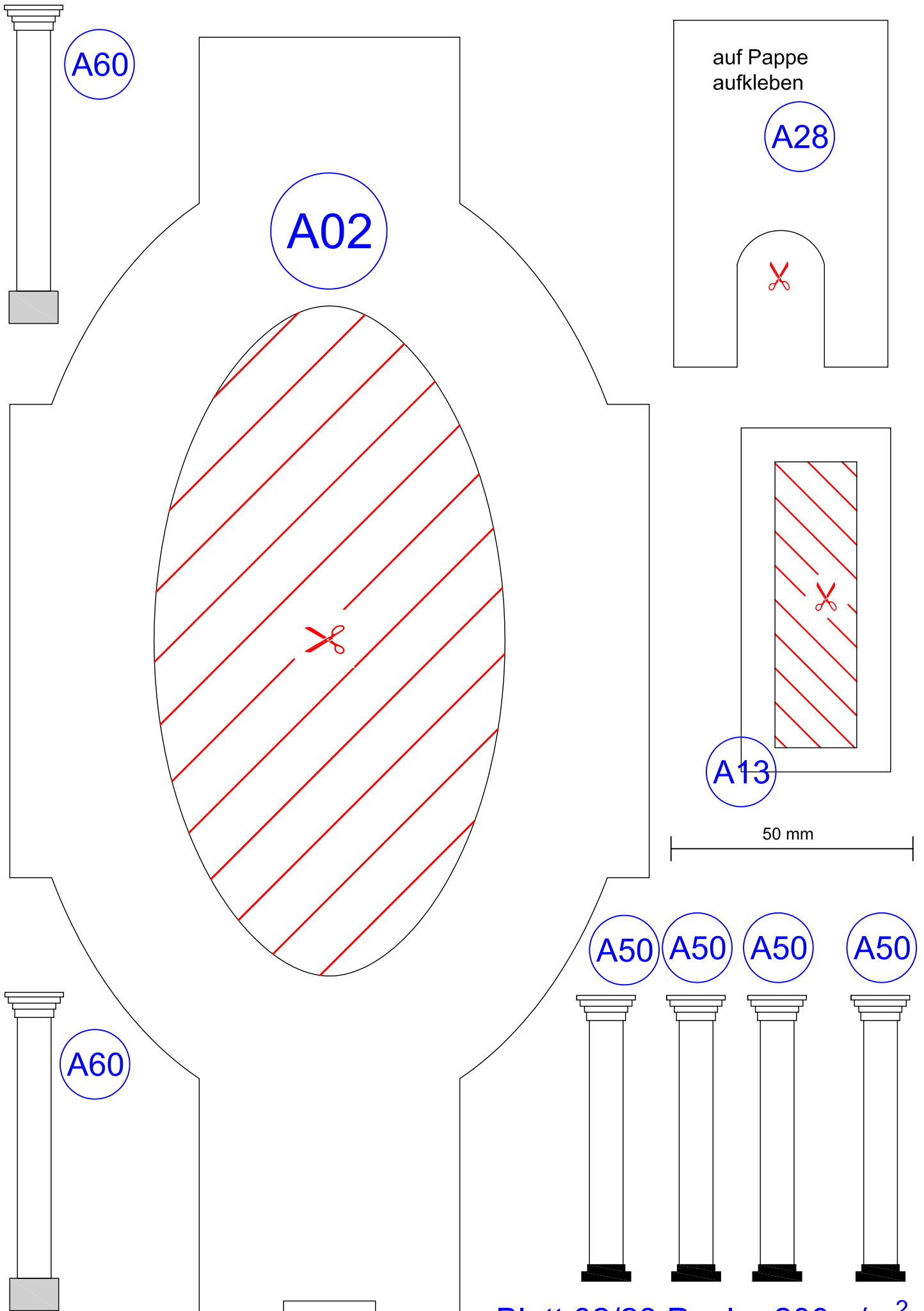

A60

A02

auf Pappe  
aufkleben

A28

A13

50 mm

A50

A50

A50

A50

A60

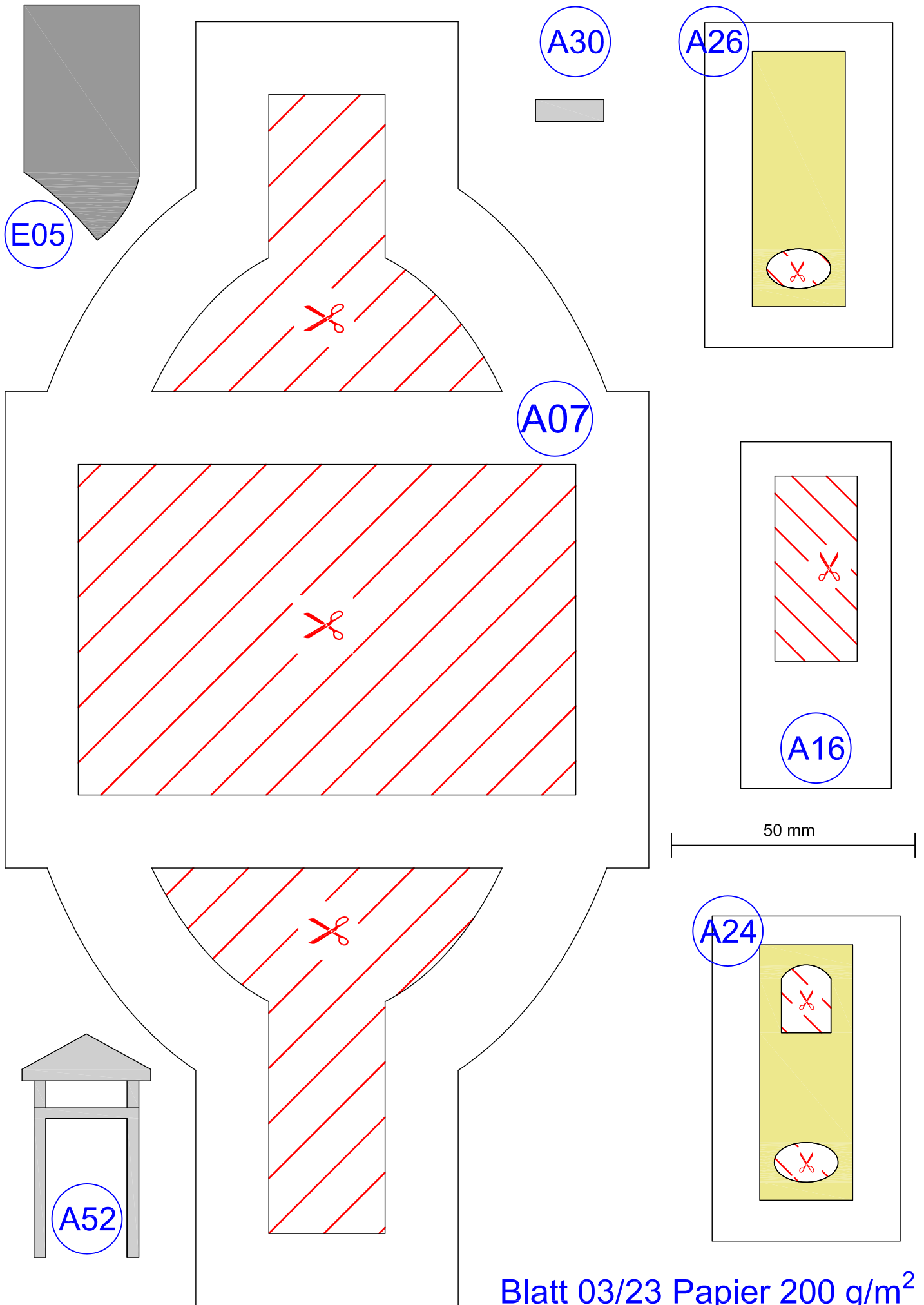

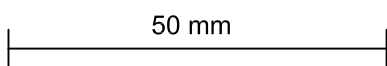
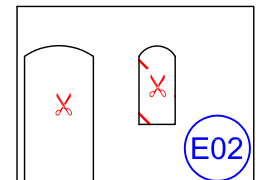
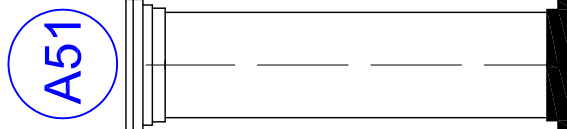
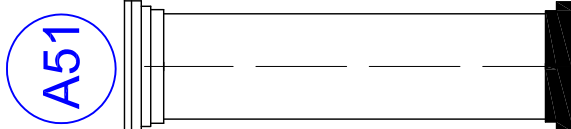
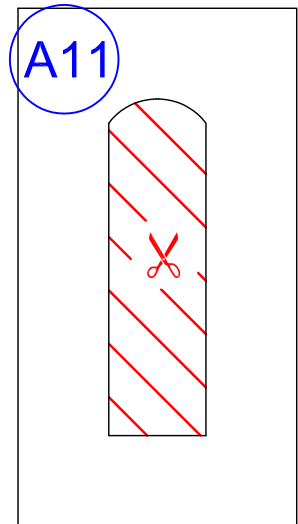
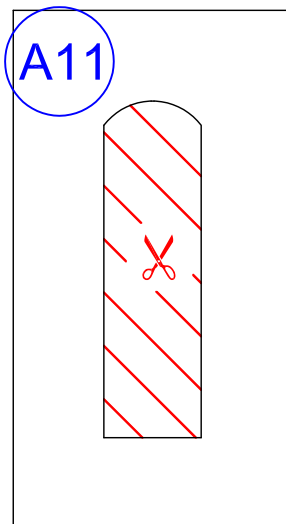
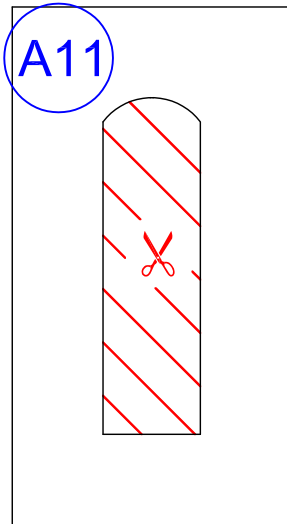
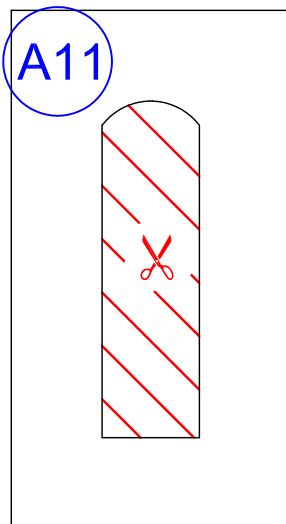
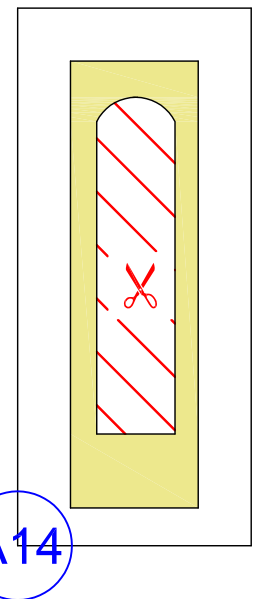
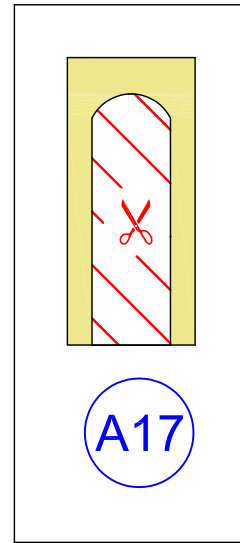
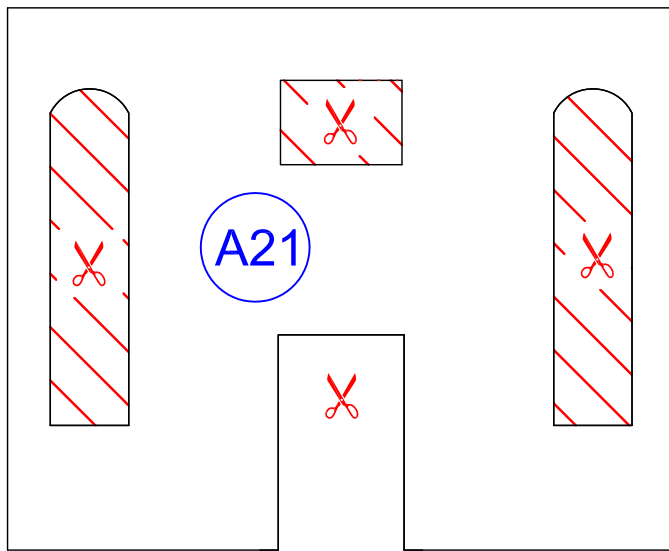
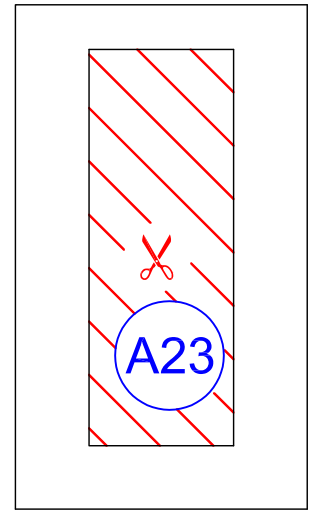
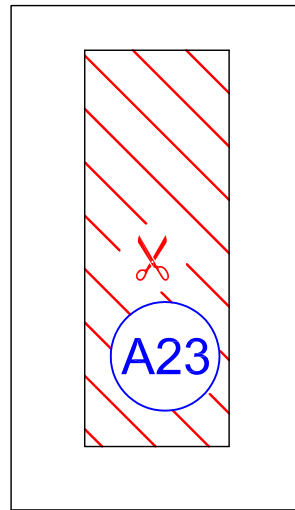
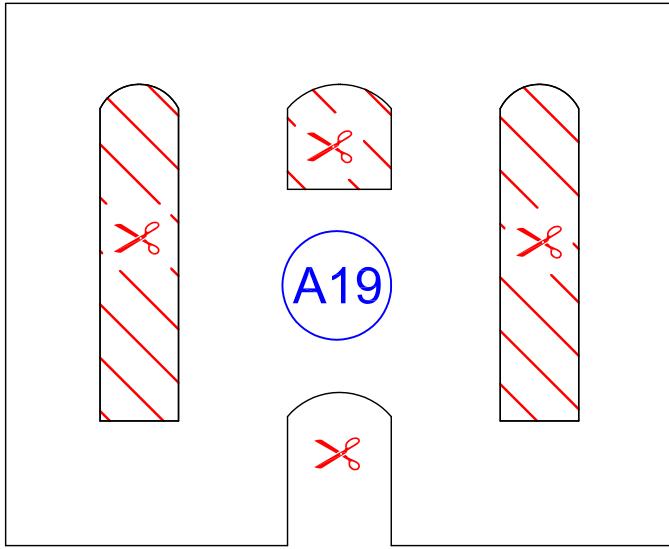

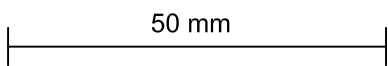
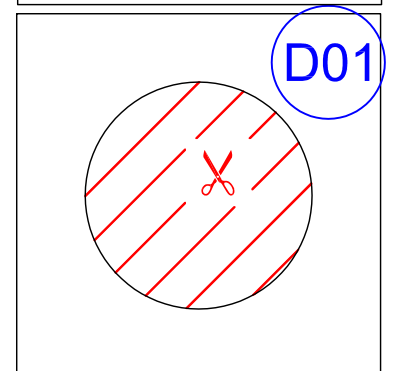
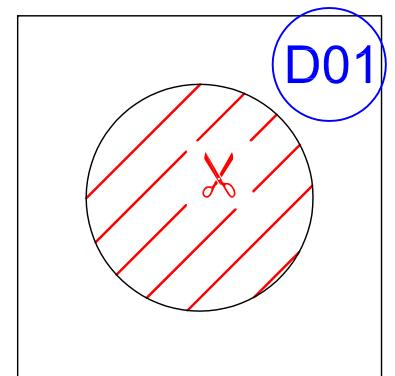
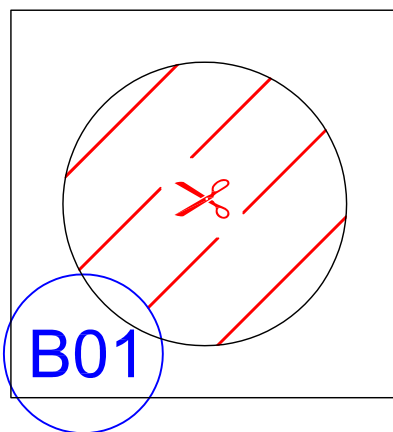
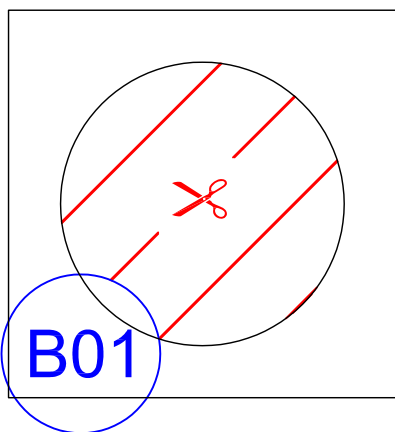
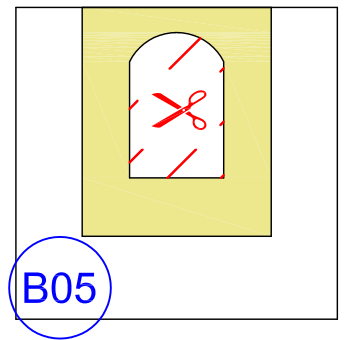
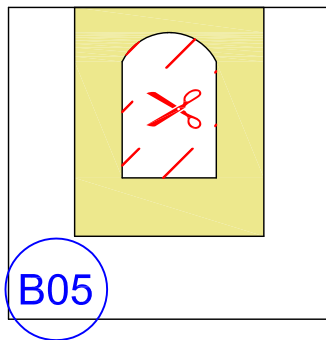
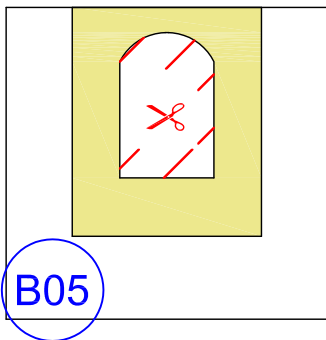
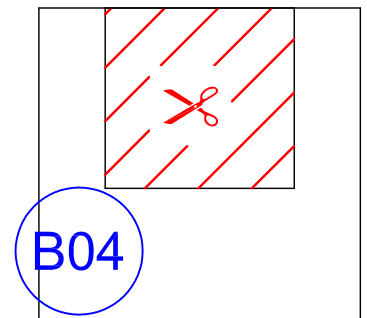
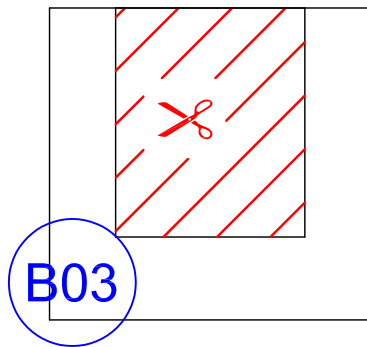
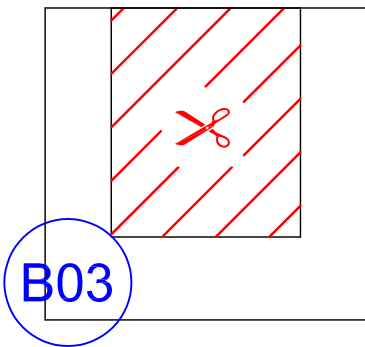
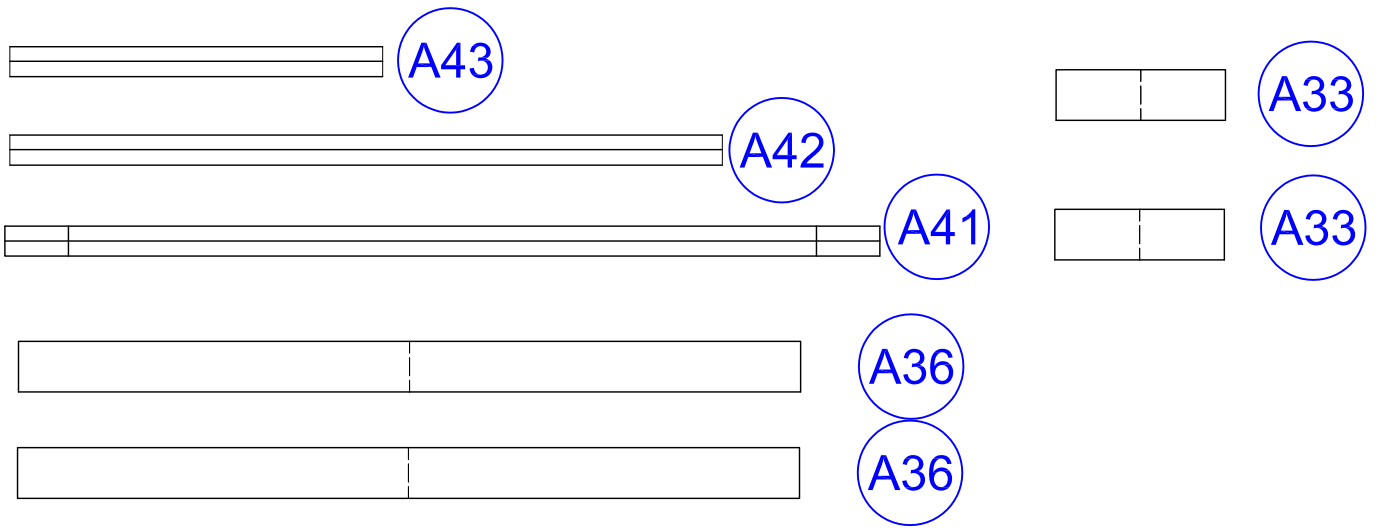

Blatt 05/23 200 g/m<sup>2</sup> oder stärker

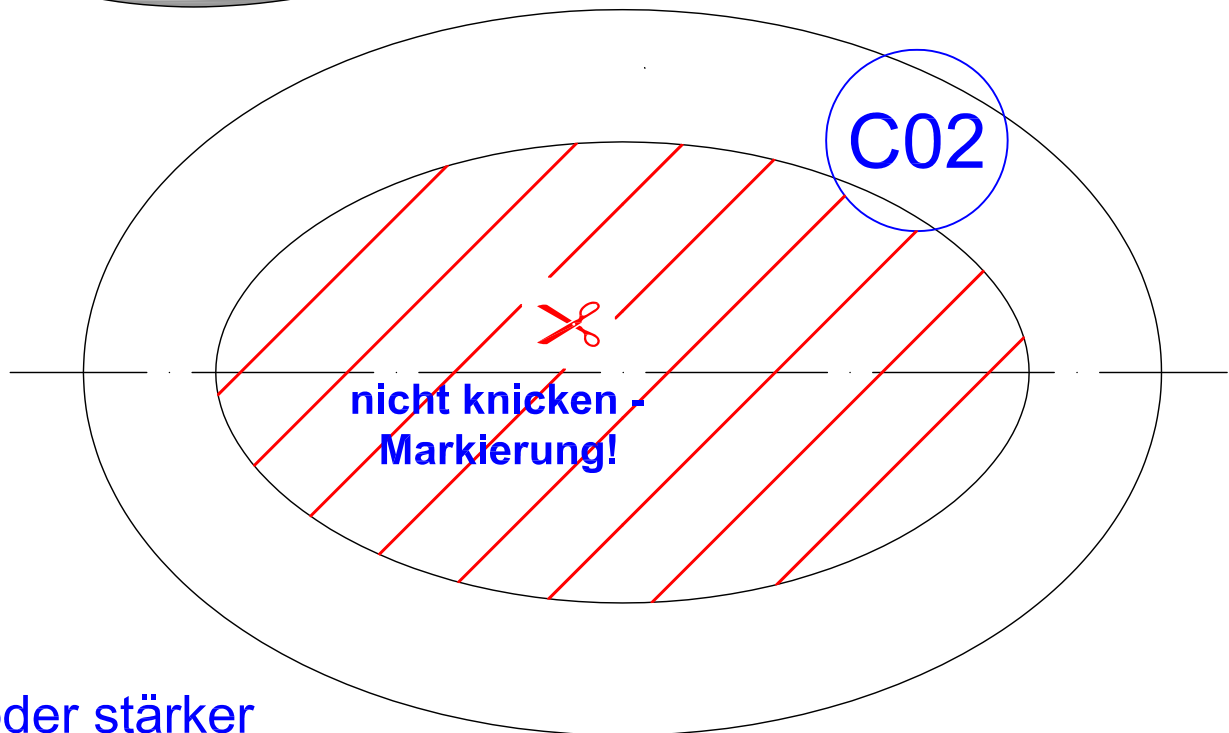
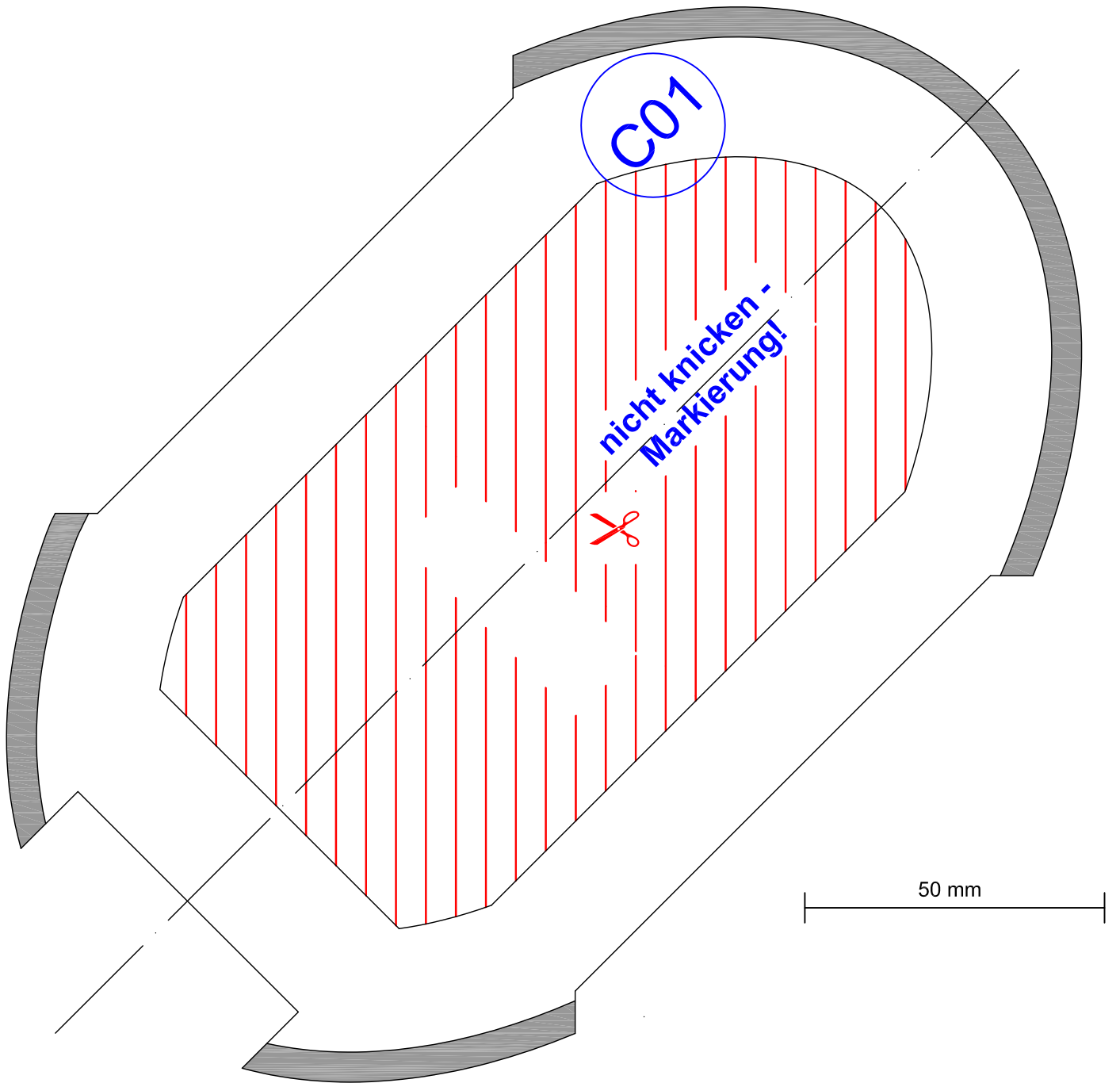

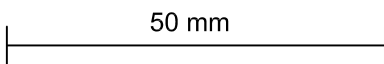
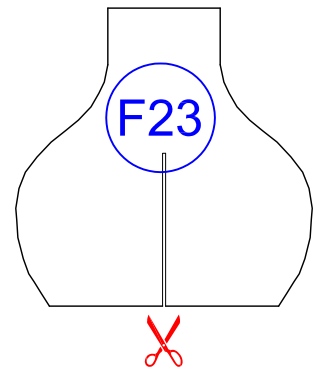
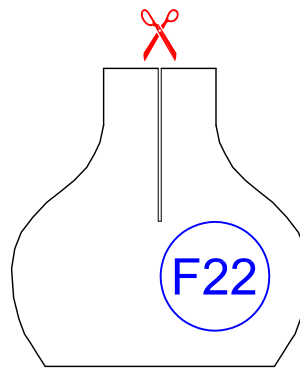
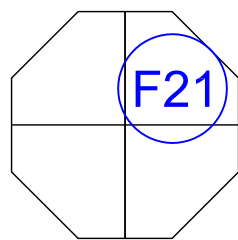
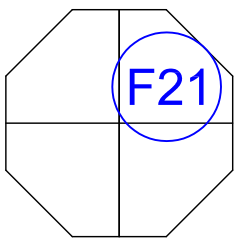
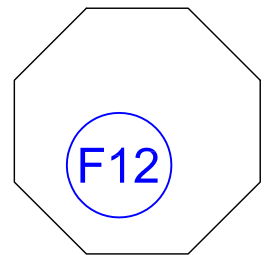
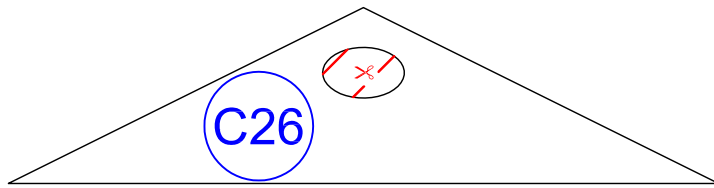
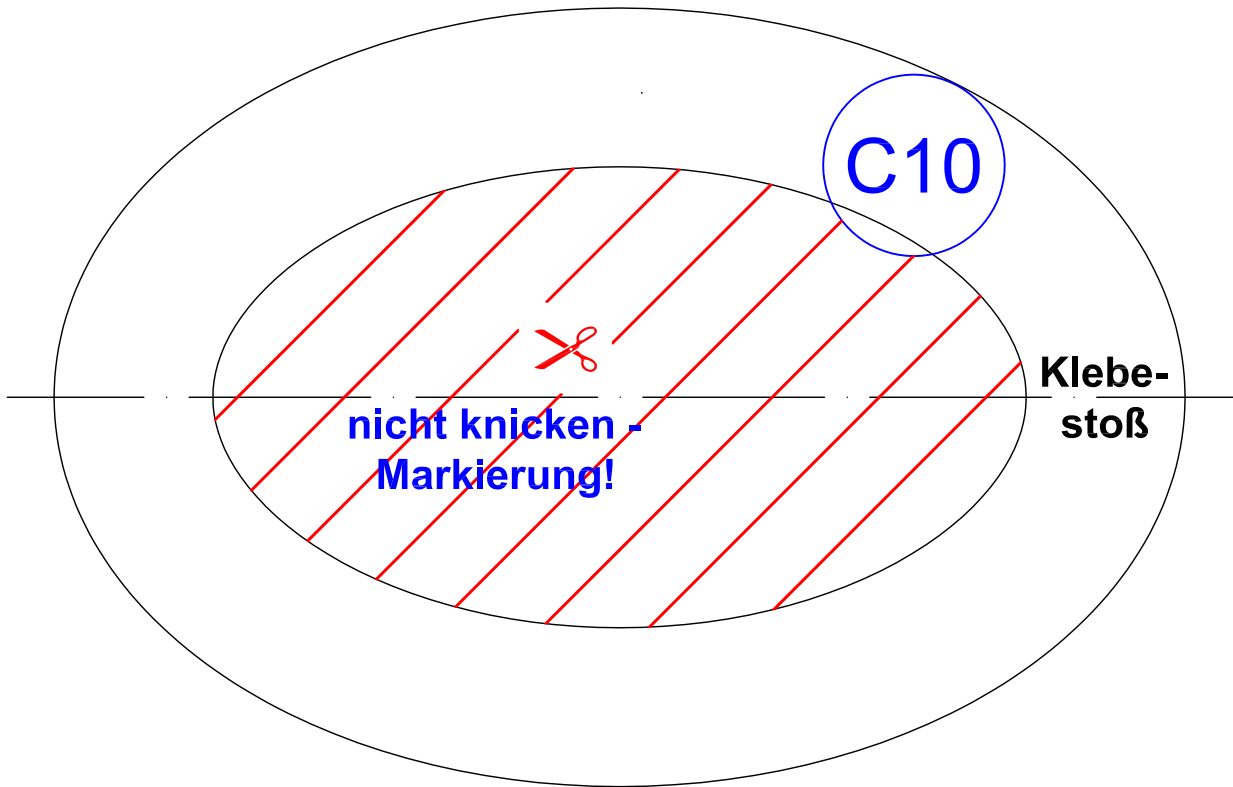

Blatt 07/23  
 200 g/m<sup>2</sup>  
 oder stärker

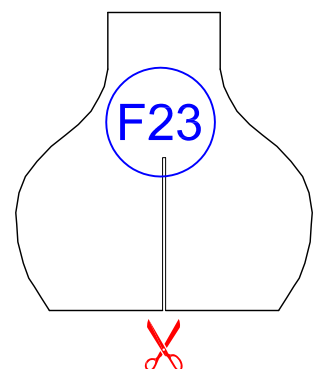
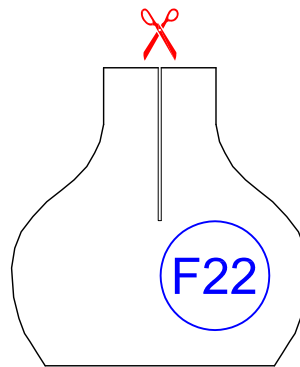

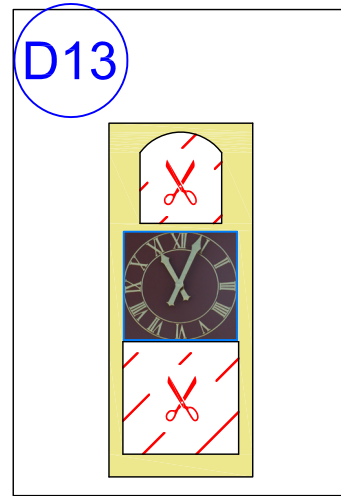
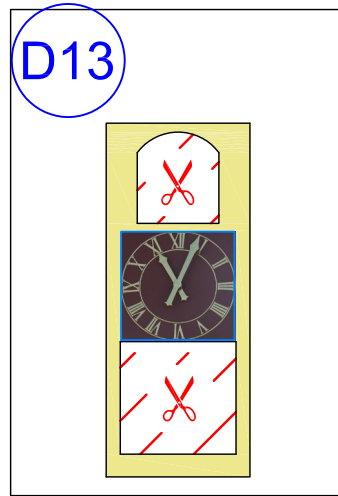
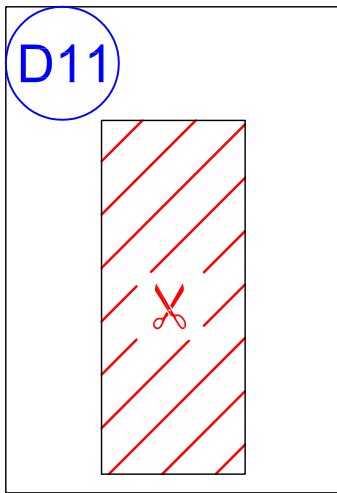
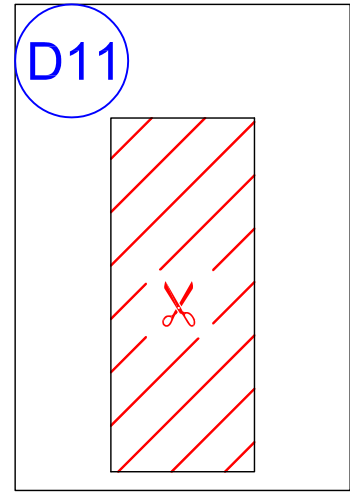
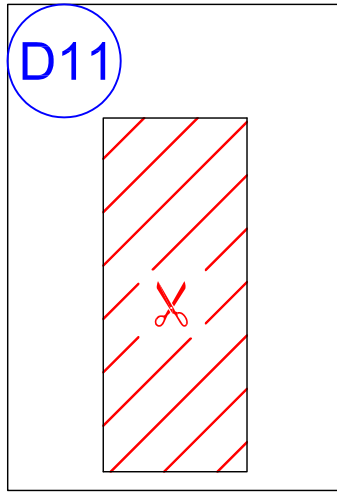
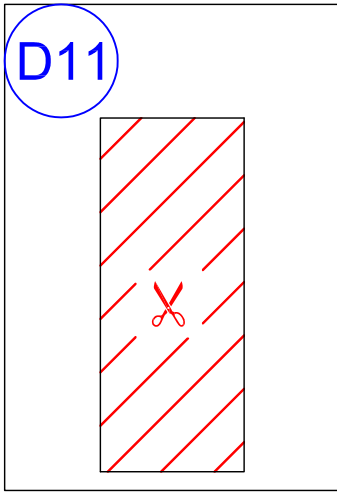

50 mm

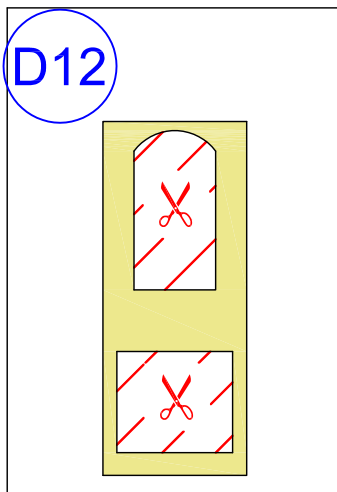
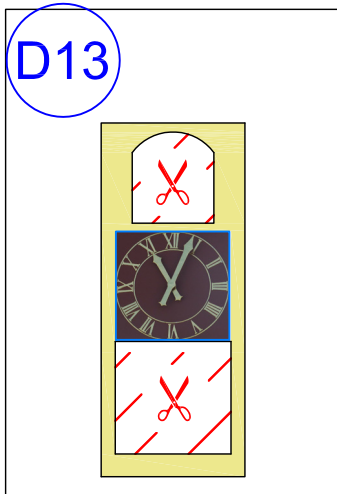



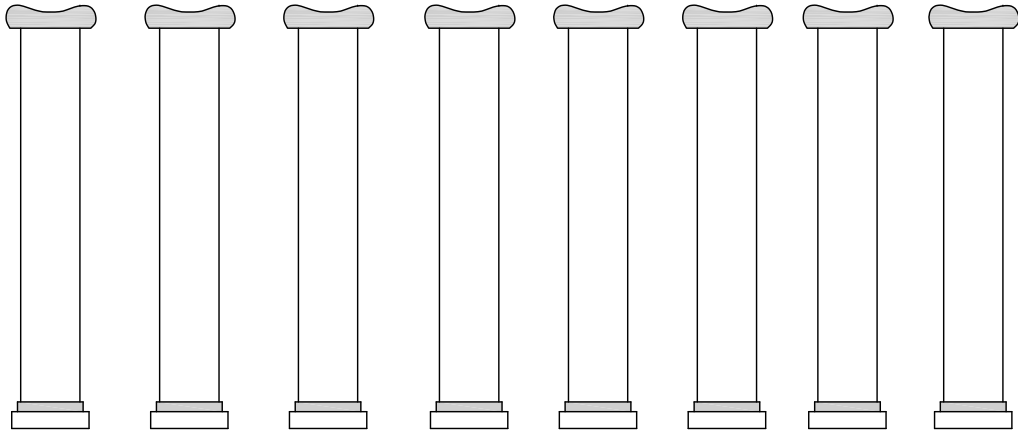

D17

D18

D18

D18

D18

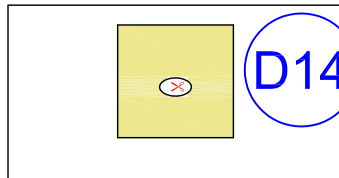
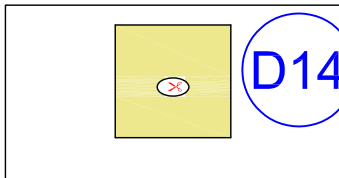
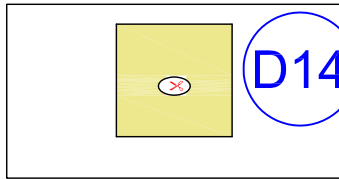
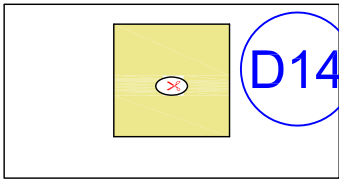
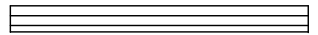
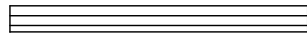
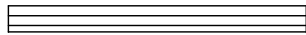
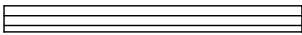

50 mm

Blatt 09/23  
200 g/m<sup>2</sup>  
oder stärker

A03

Teil A07 anleben

Teil A02 anleben

50 mm

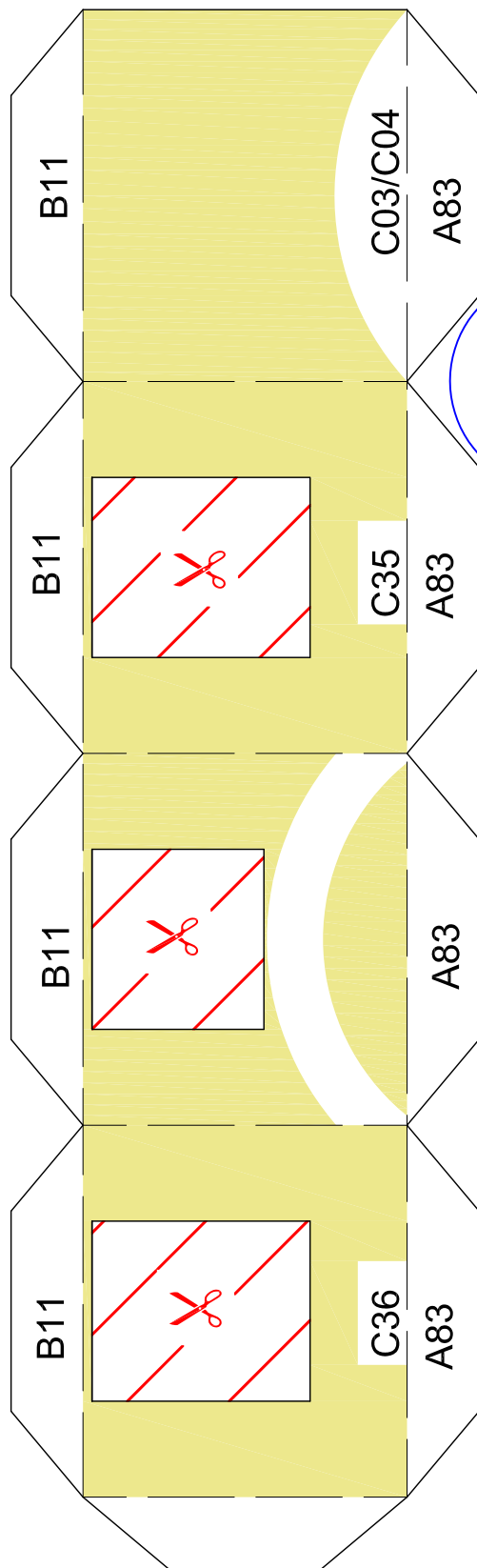
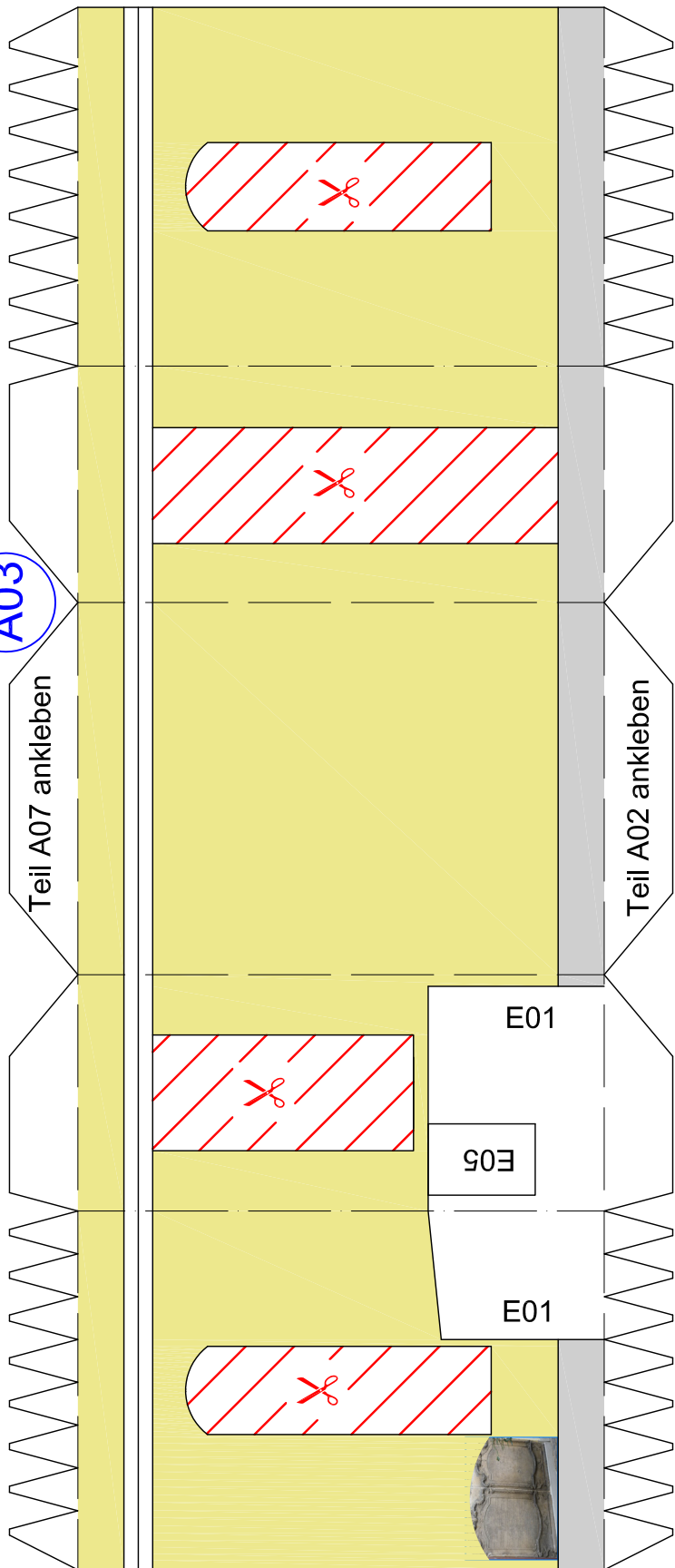

B02

Blatt 10/23  
160 g/m<sup>2</sup> oder stärker

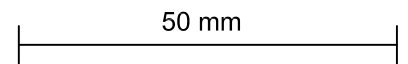
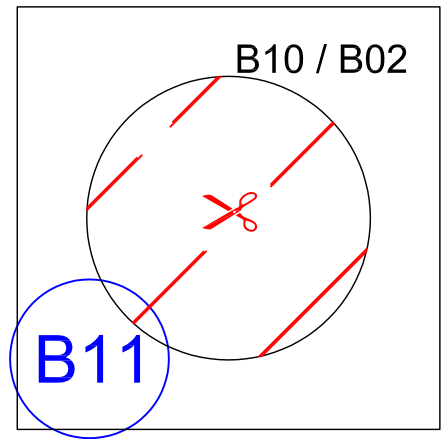
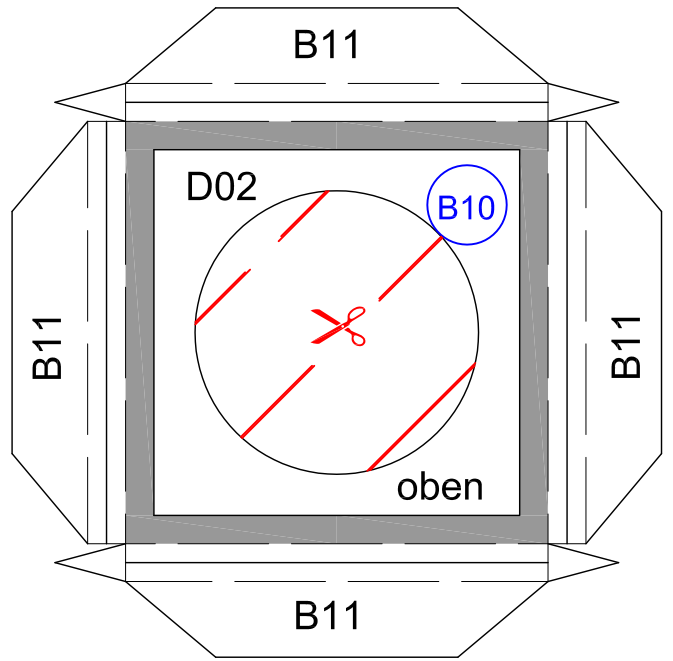
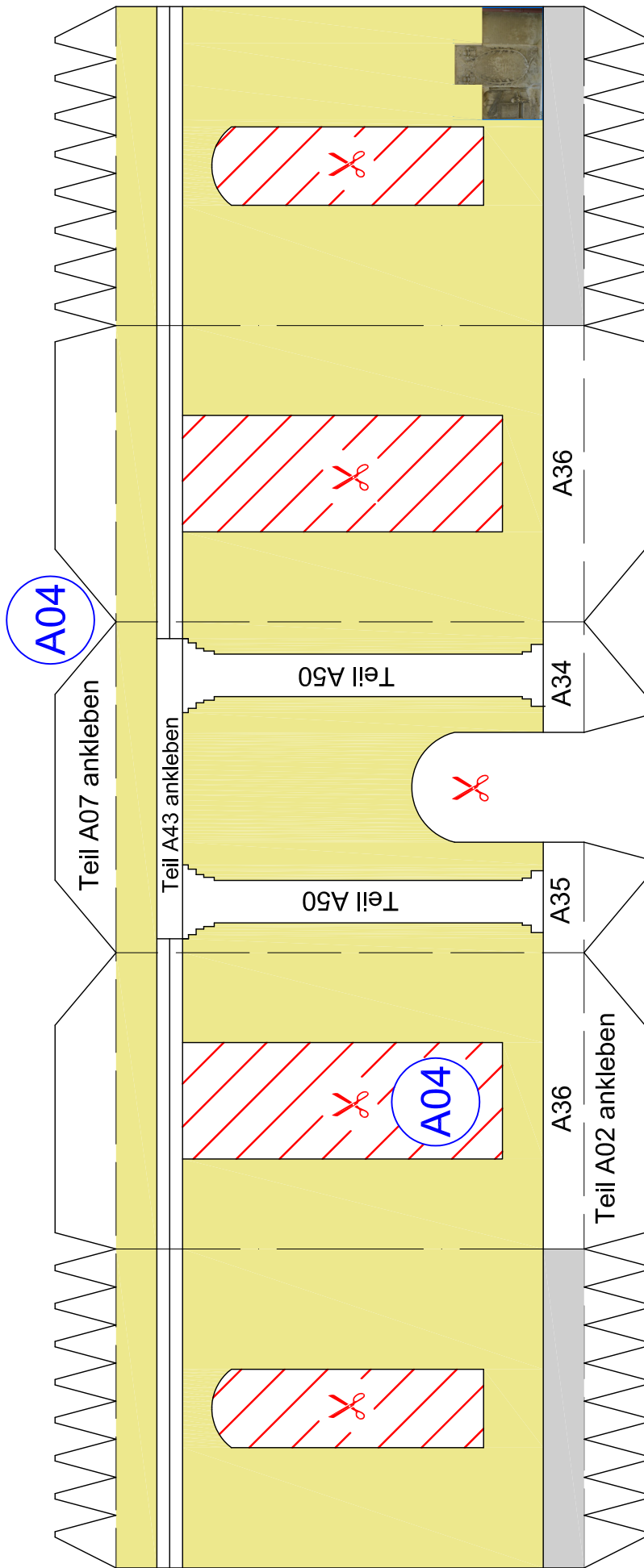

Blatt 11/23  
160 g/m<sup>2</sup> oder stärker

A05

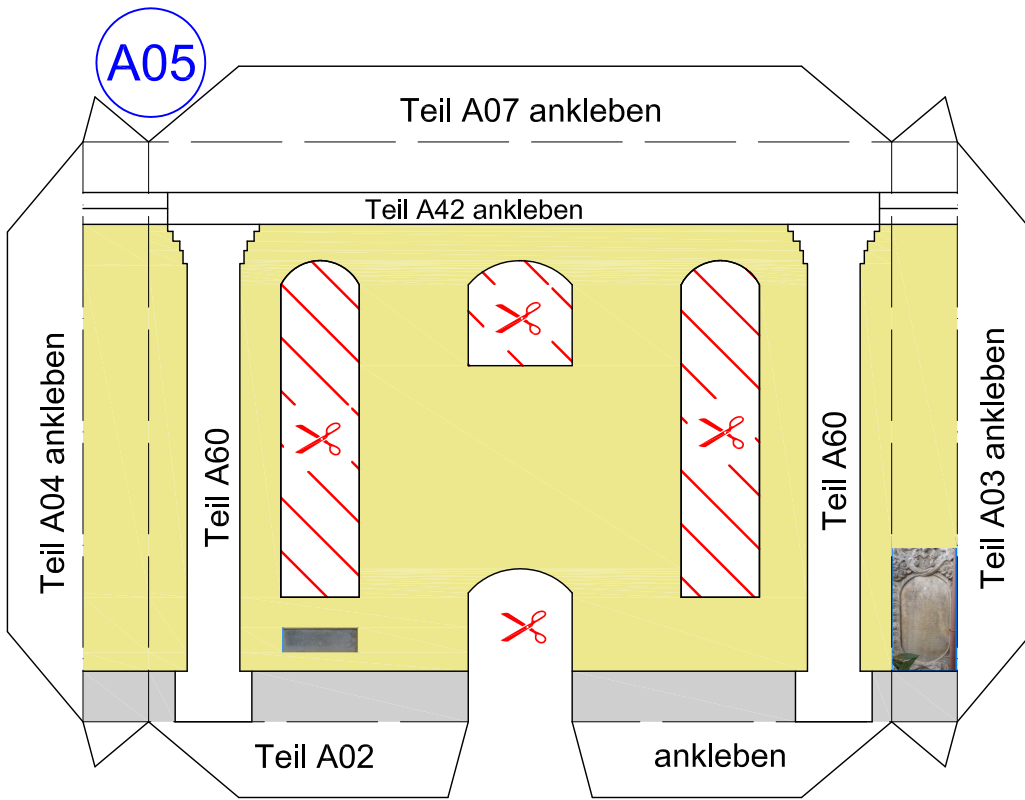

A06

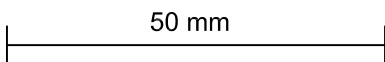
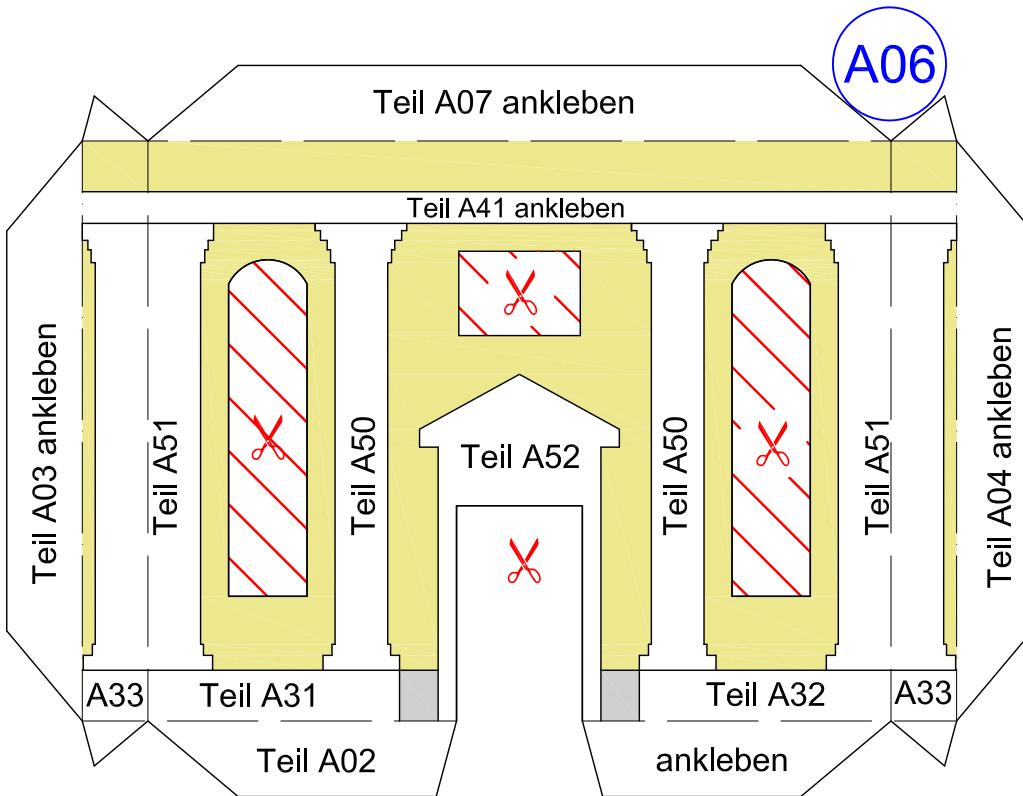

Blatt 13/23  
160 g/m<sup>2</sup> oder stärker

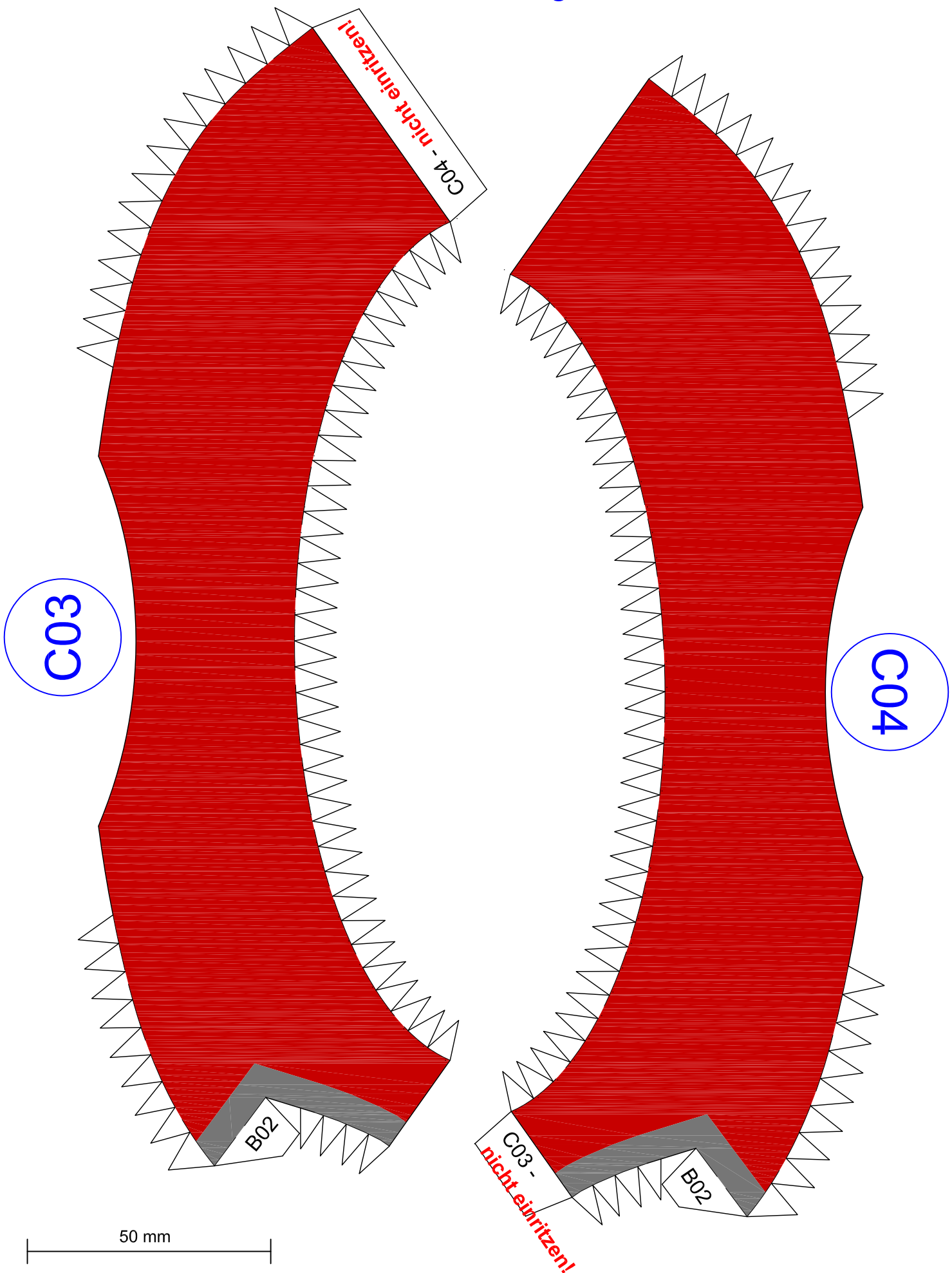

50 mm

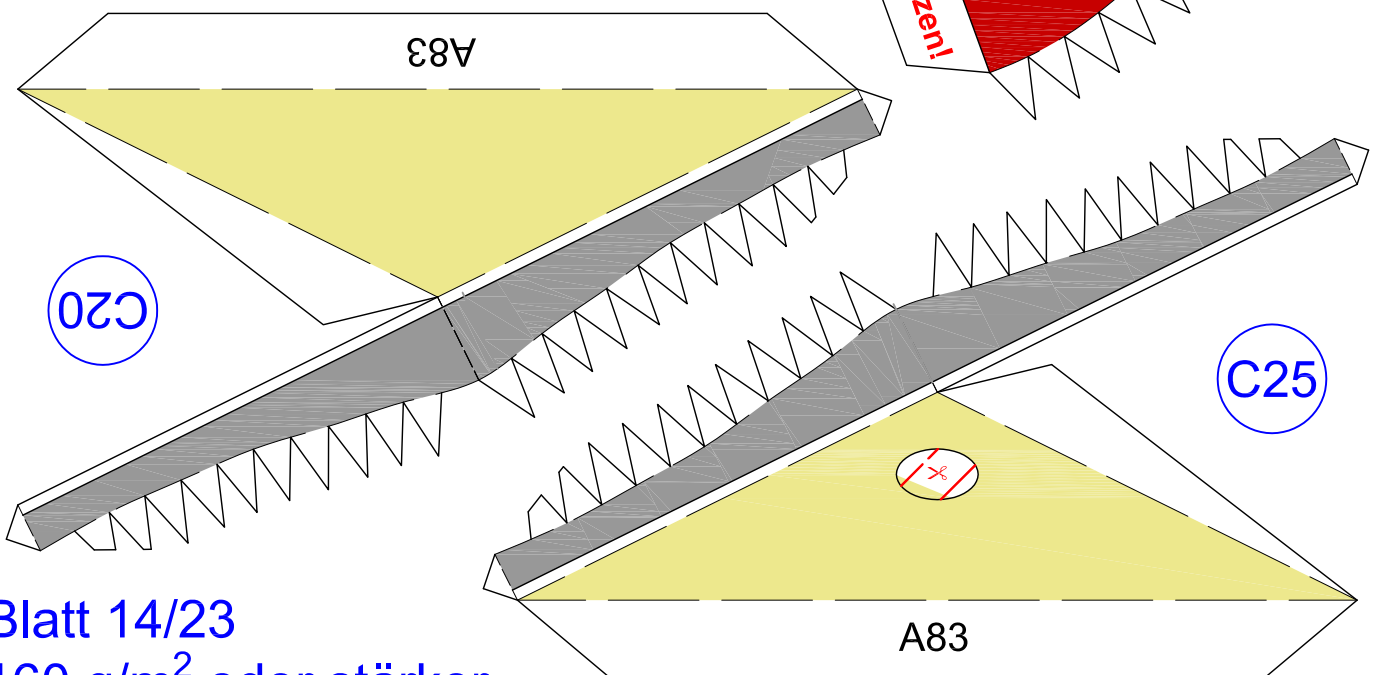
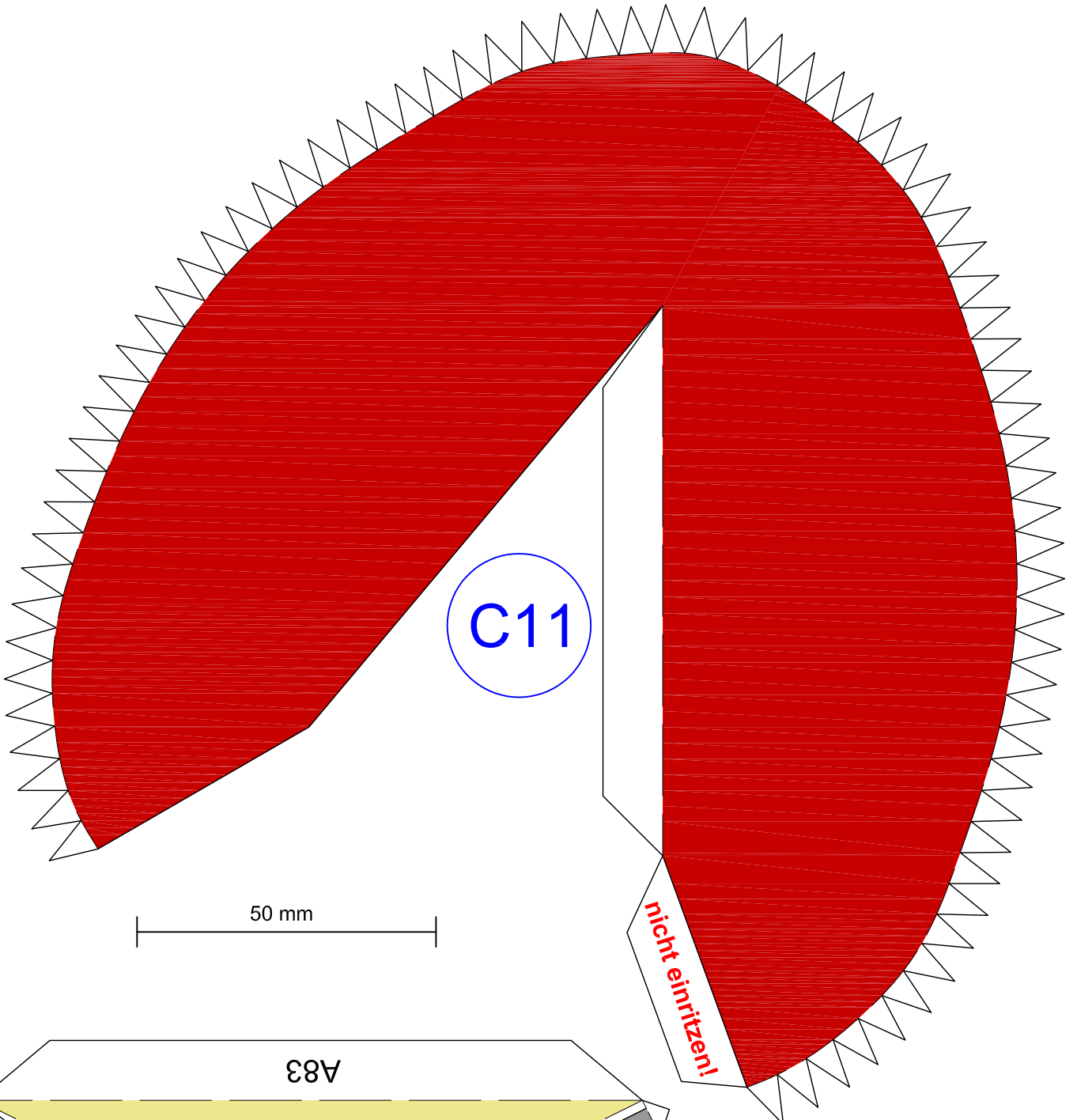

Blatt 14/23  
160 g/m<sup>2</sup> oder stärker

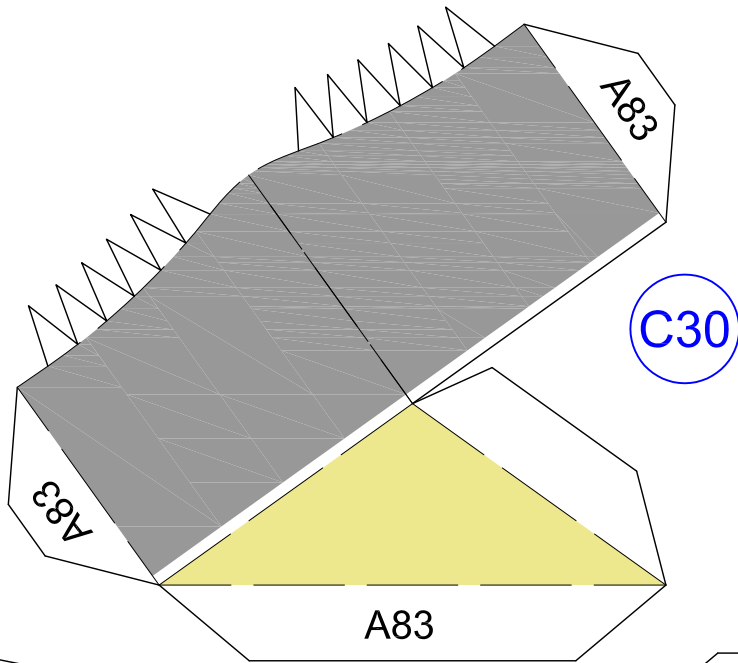

50 mm

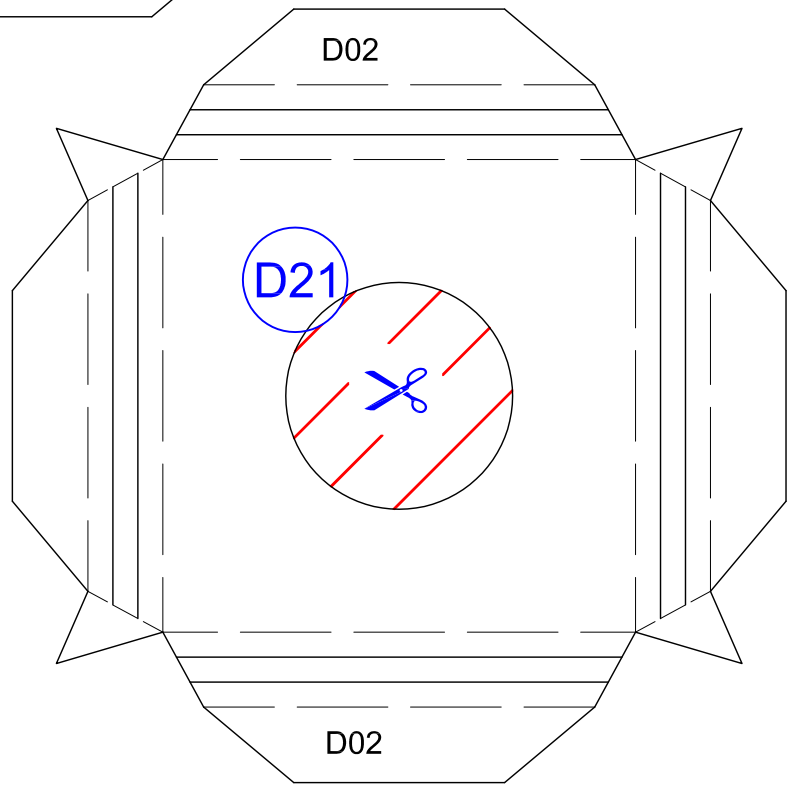
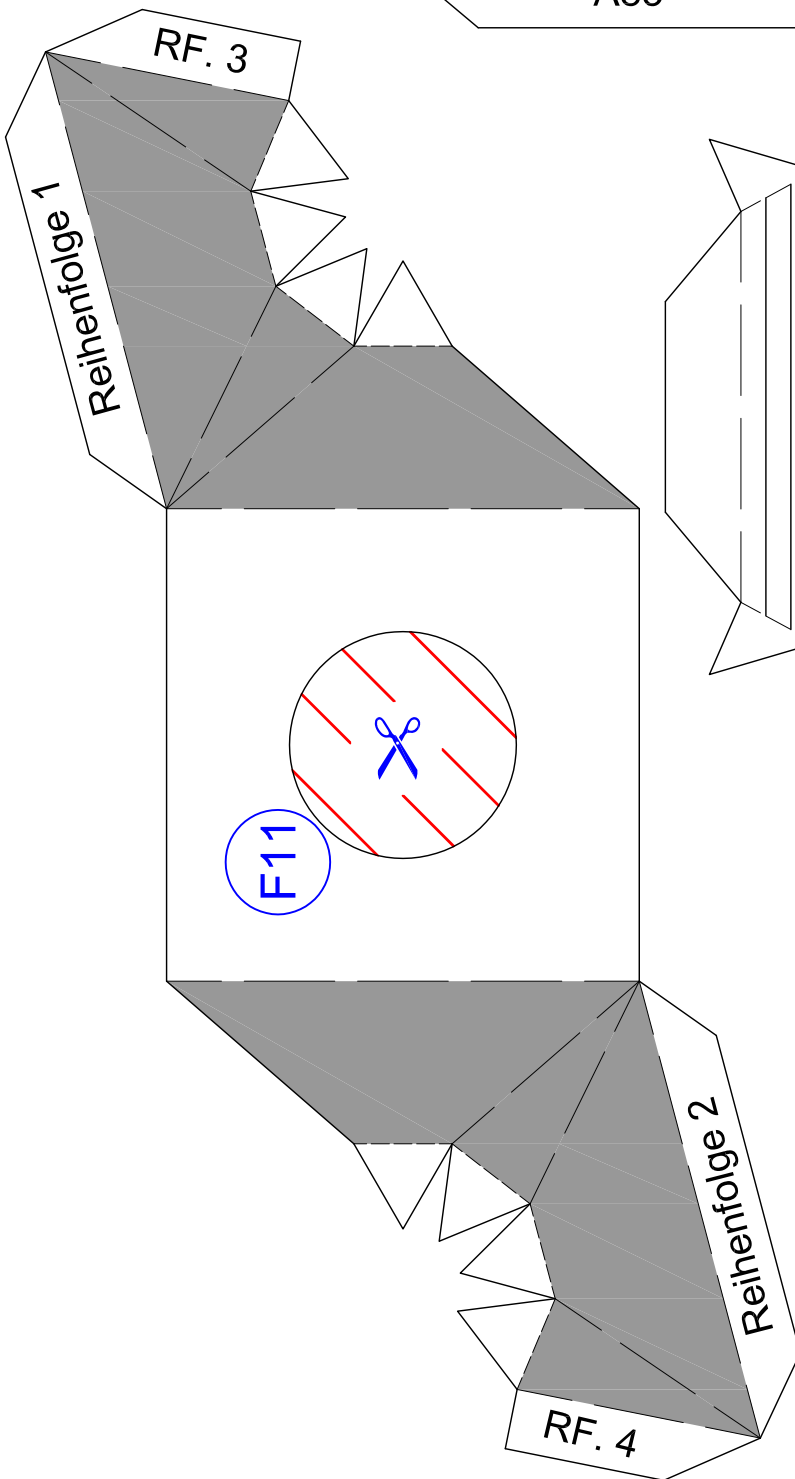

Blatt 15/23 160 g/m<sup>2</sup>  
oder stärker

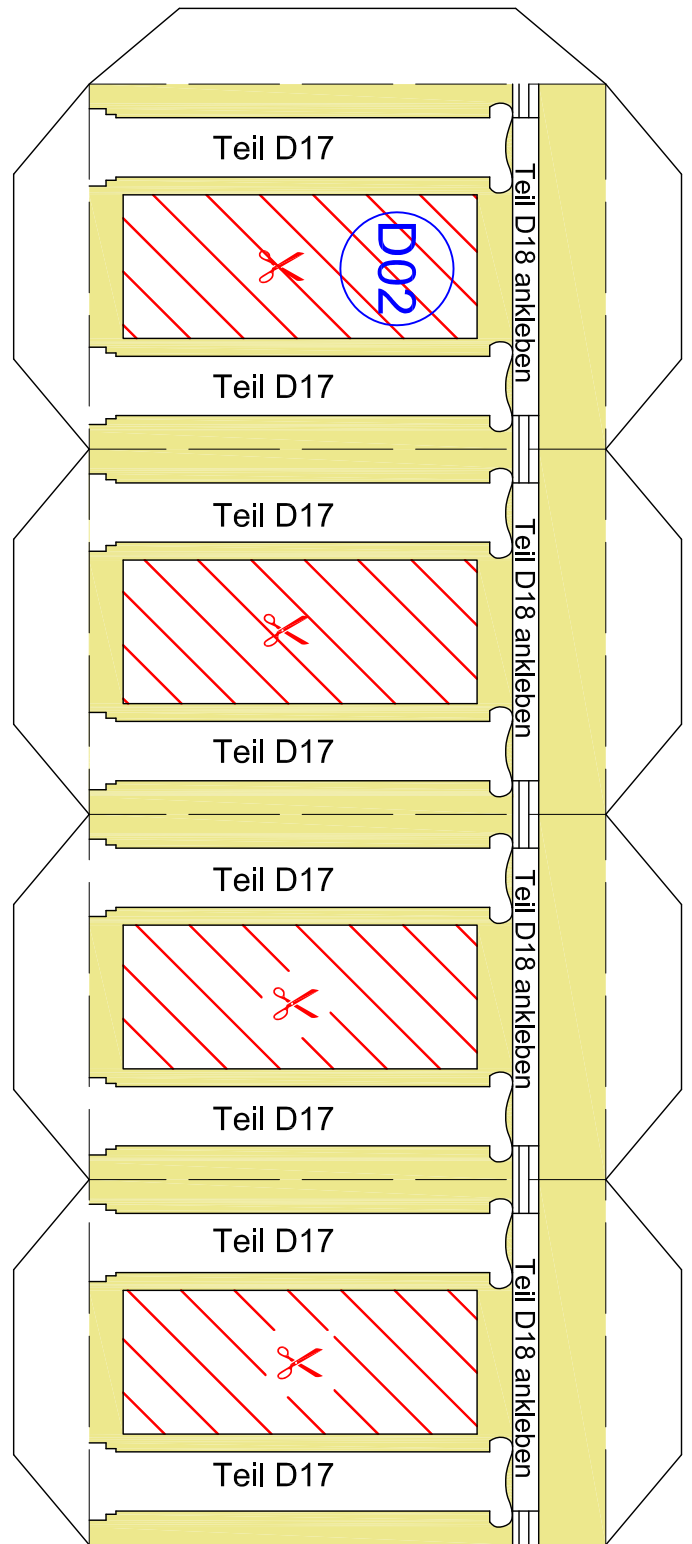
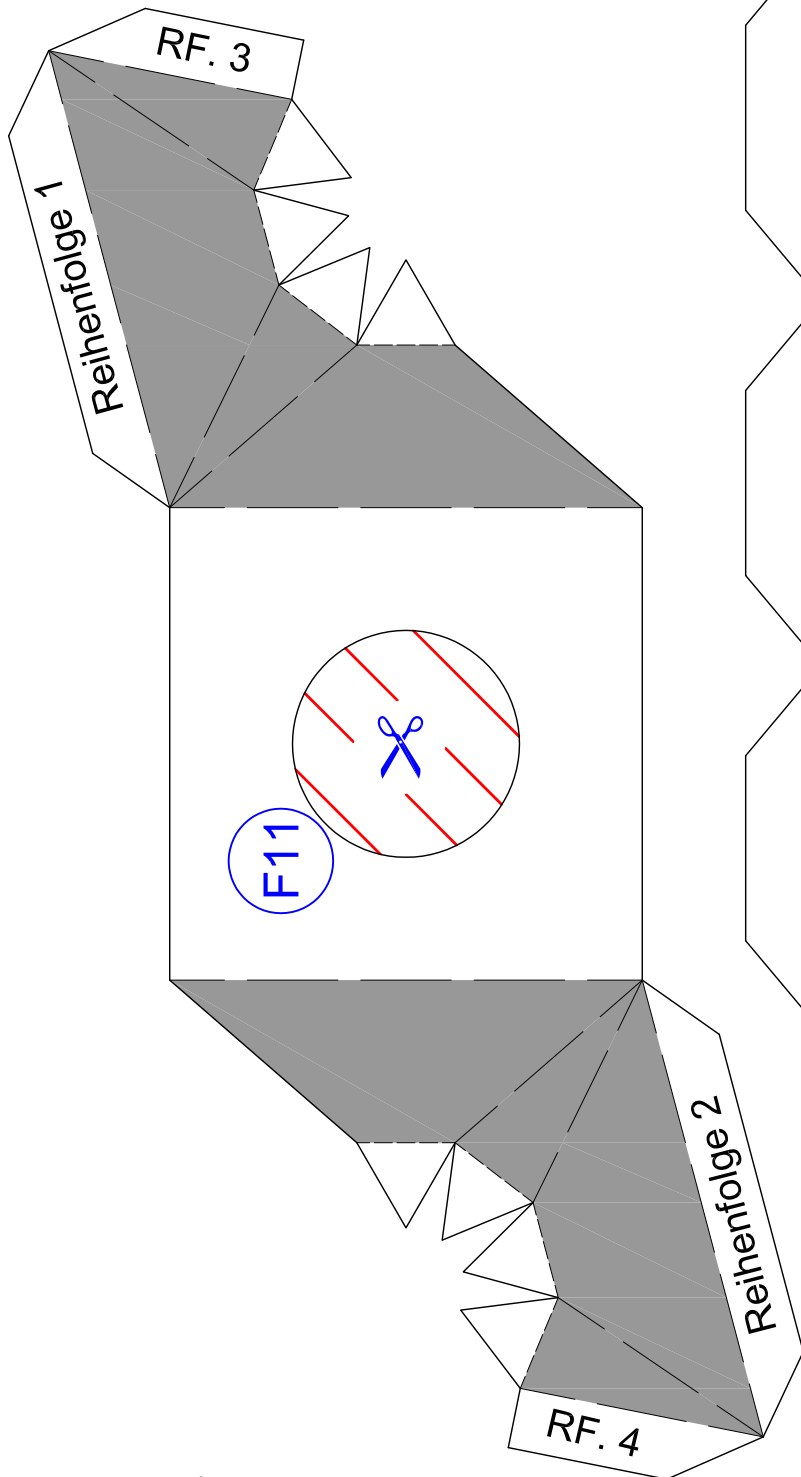

Blatt 16/23  
 160 g/m<sup>2</sup>  
 oder stärker



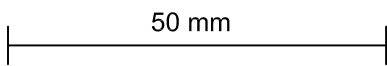
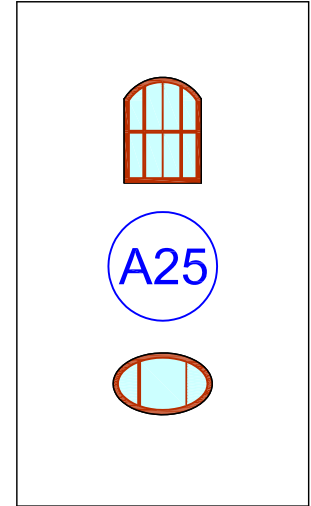
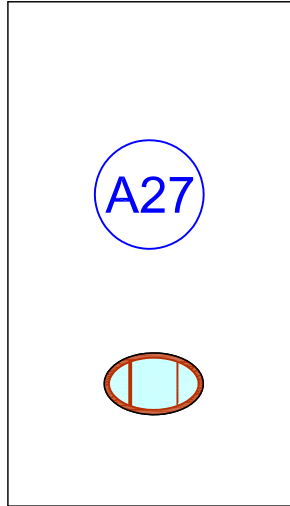
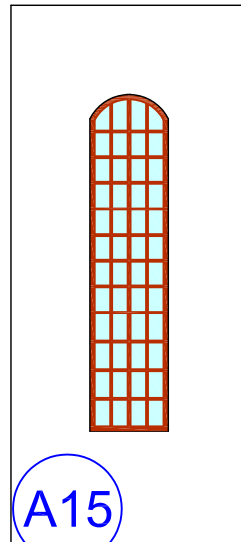
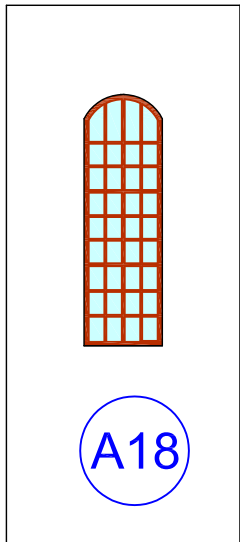
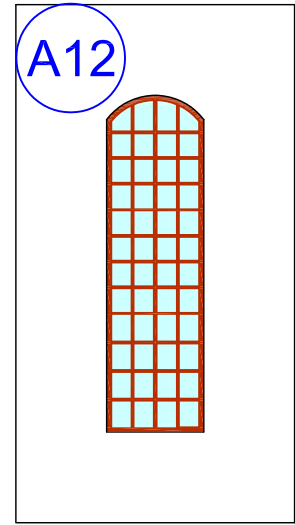
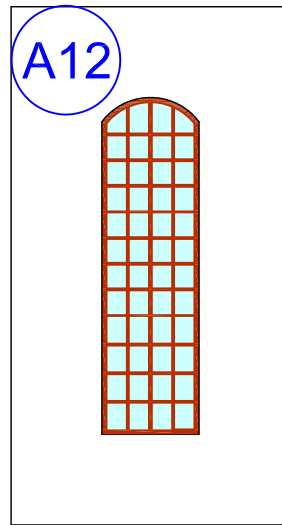
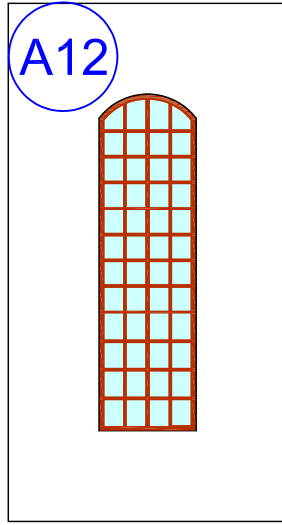
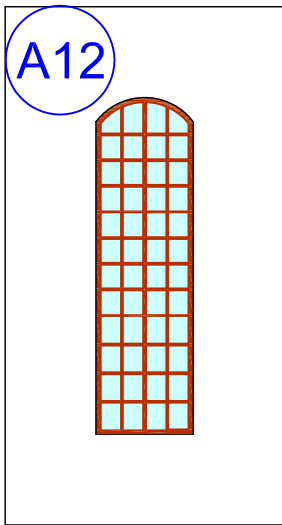
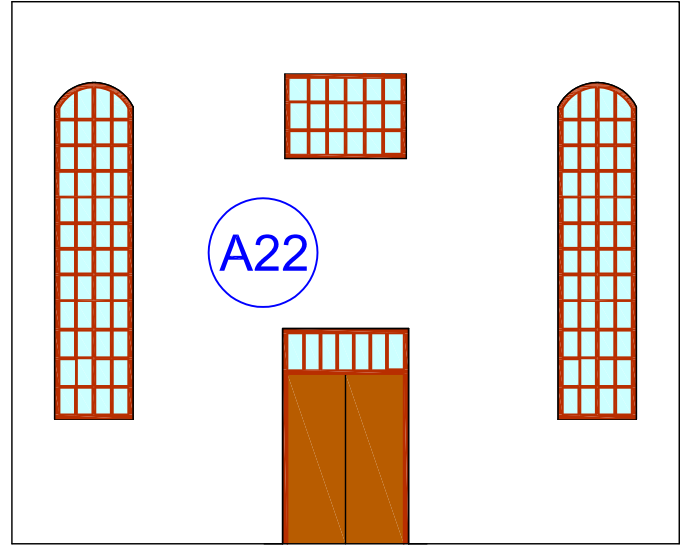
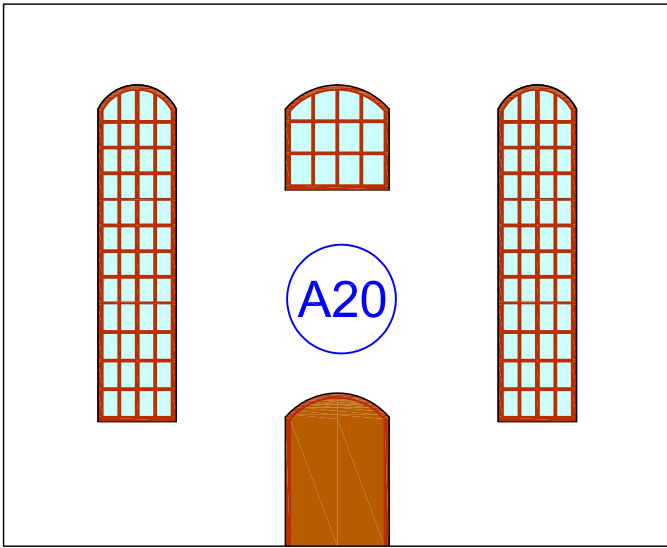

Blatt 17/23 80 g/m<sup>2</sup> oder stärker

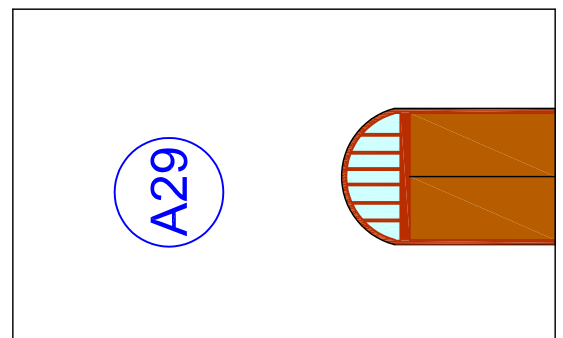

A70

Blatt 18/23  
80 g/m<sup>2</sup> oder stärker

**Georgenkirche**

Dessau-Roßlau  
Ecke Georgenstraße / Askanische Straße  
Design: **Helmut Lucas** - 2017  
Maßstab: 1 : 120

A80

**untere Schicht**  
vor dem Ausschneiden auf  
Pappe aufkleben

B06



B16

B17



50 mm

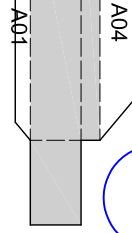

A32

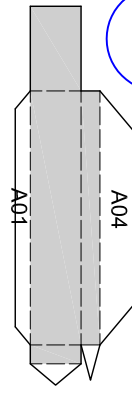

A31

Blatt 19/23  
80 g/m<sup>2</sup>  
oder stärker

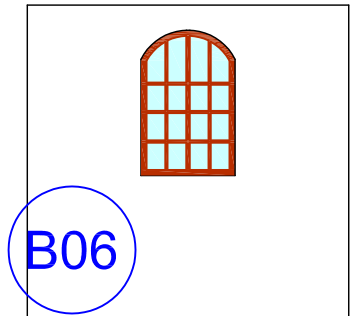
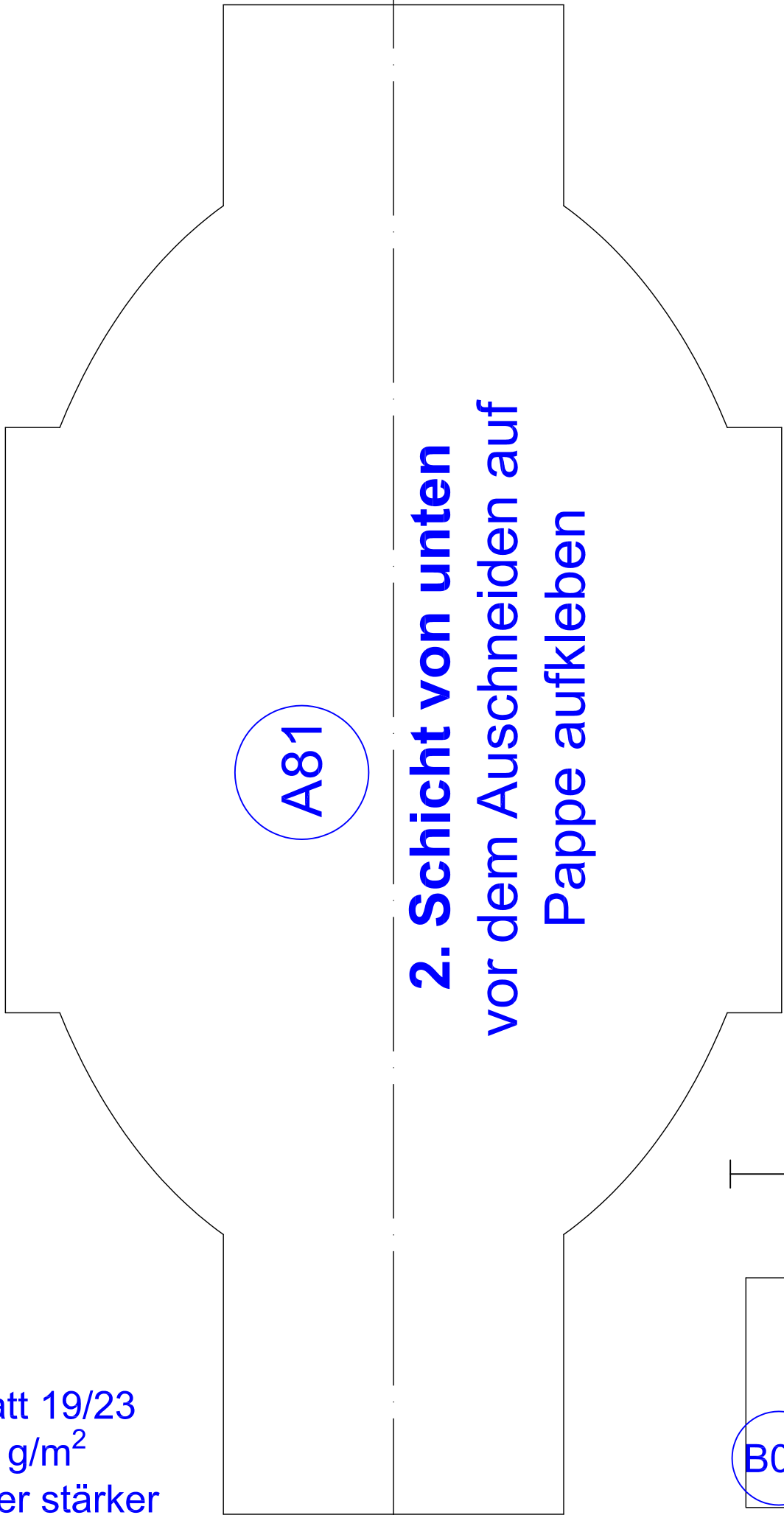

50 mm

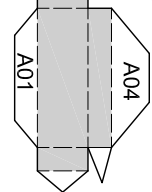
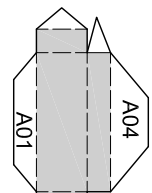

Blatt 20/23  
80 g/m<sup>2</sup>  
oder stärker

A82

**3. Schicht von unten**  
vor dem Ausschneiden auf  
Pappe aufkleben

B15

50 mm

B06



Blatt 21/23  
80 g/m<sup>2</sup>  
oder stärker

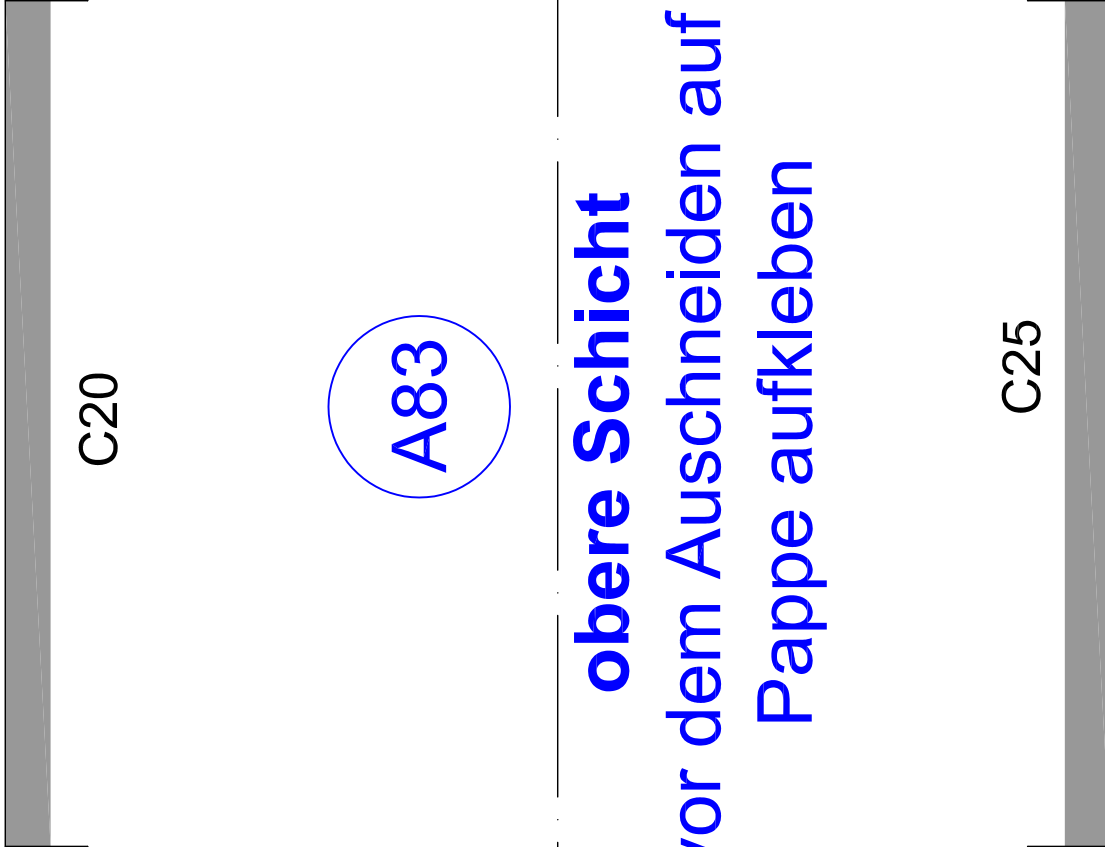

**obere Schicht**  
**vor dem Ausschneiden auf**  
**Pappe aufkleben**

Teil B01 mit B02  
(nächste Turmetage)  
ankleben

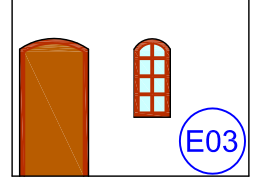

E05 A03

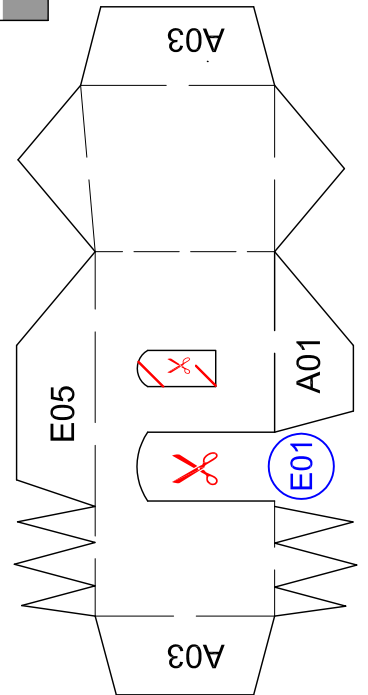
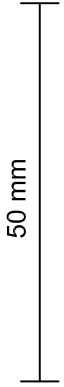

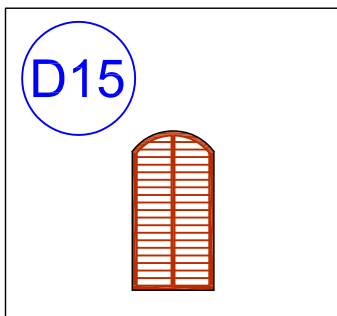
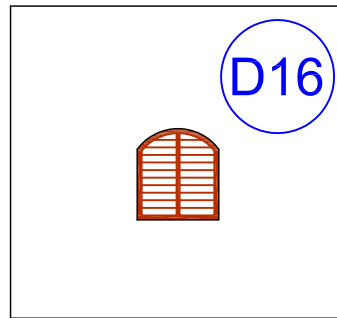
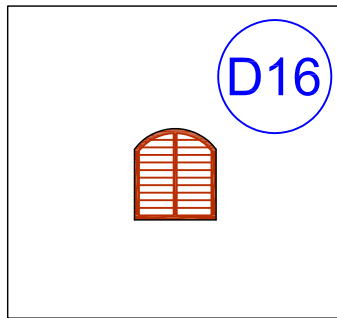
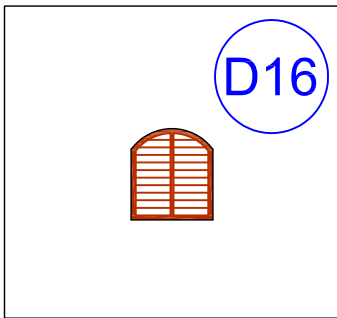
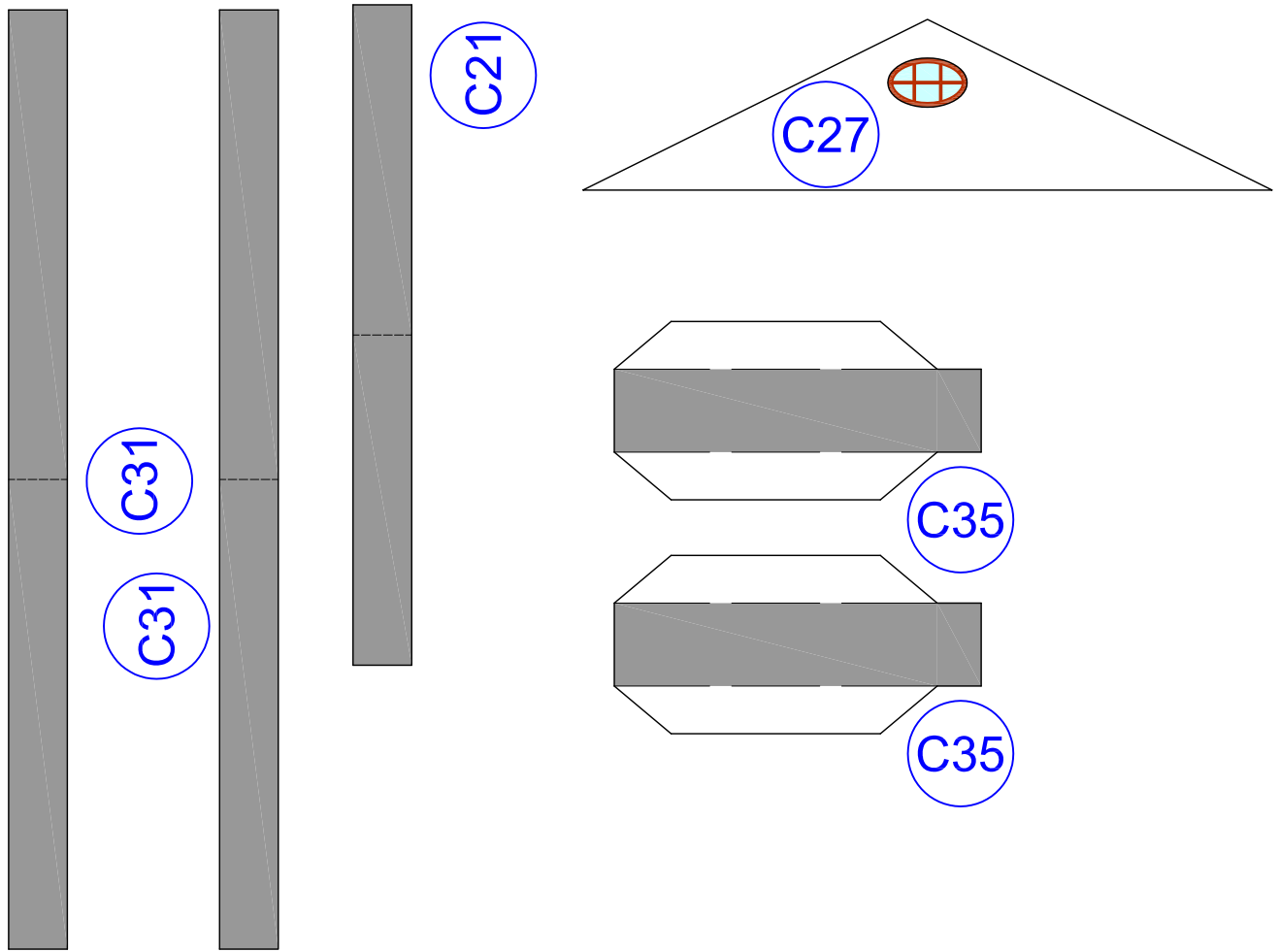

Blatt 22/23 80 g/m<sup>2</sup> oder stärker

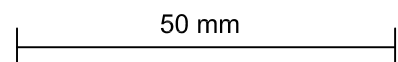

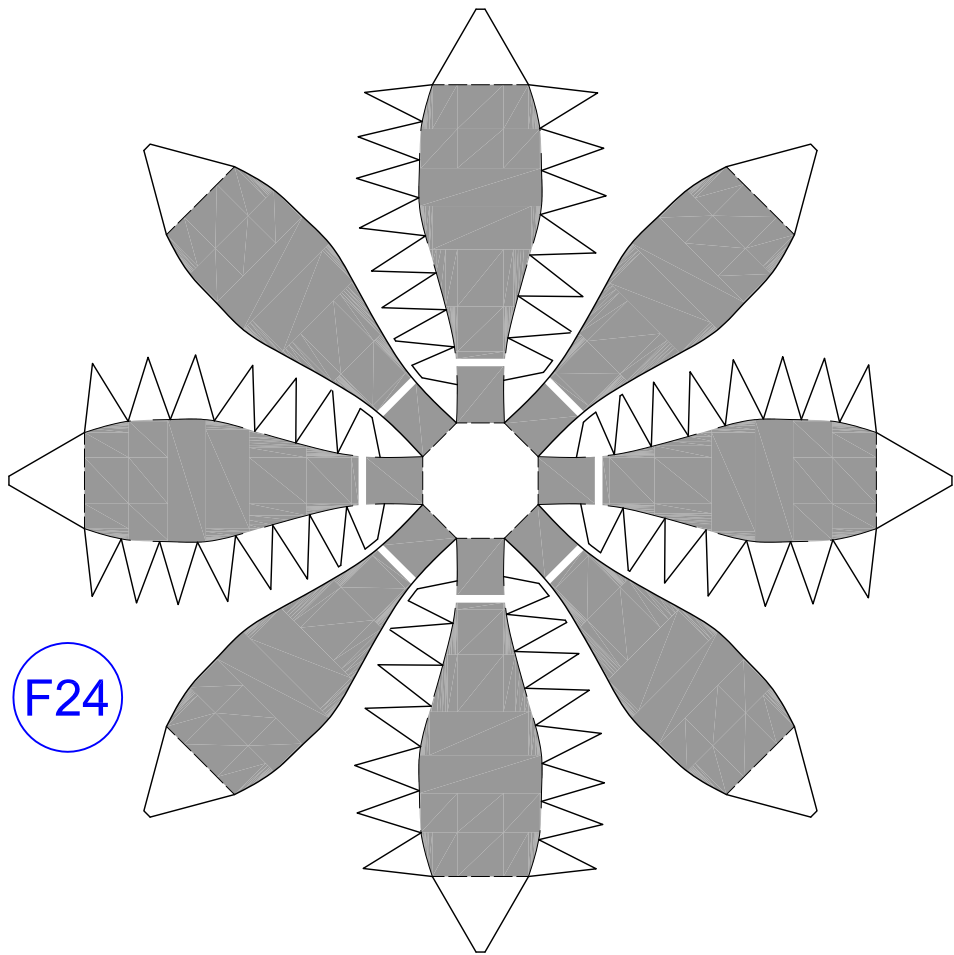

F24

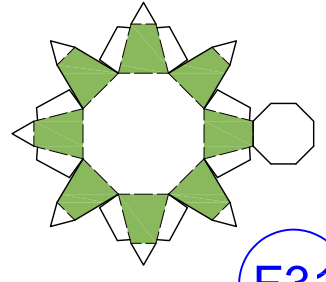

F31

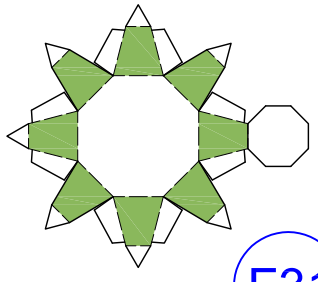

F31

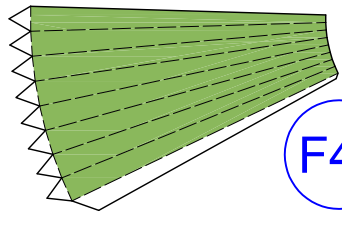

F41

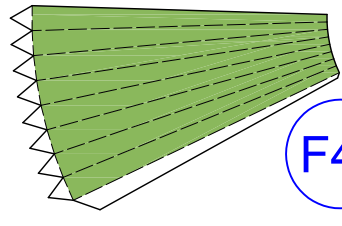

F41

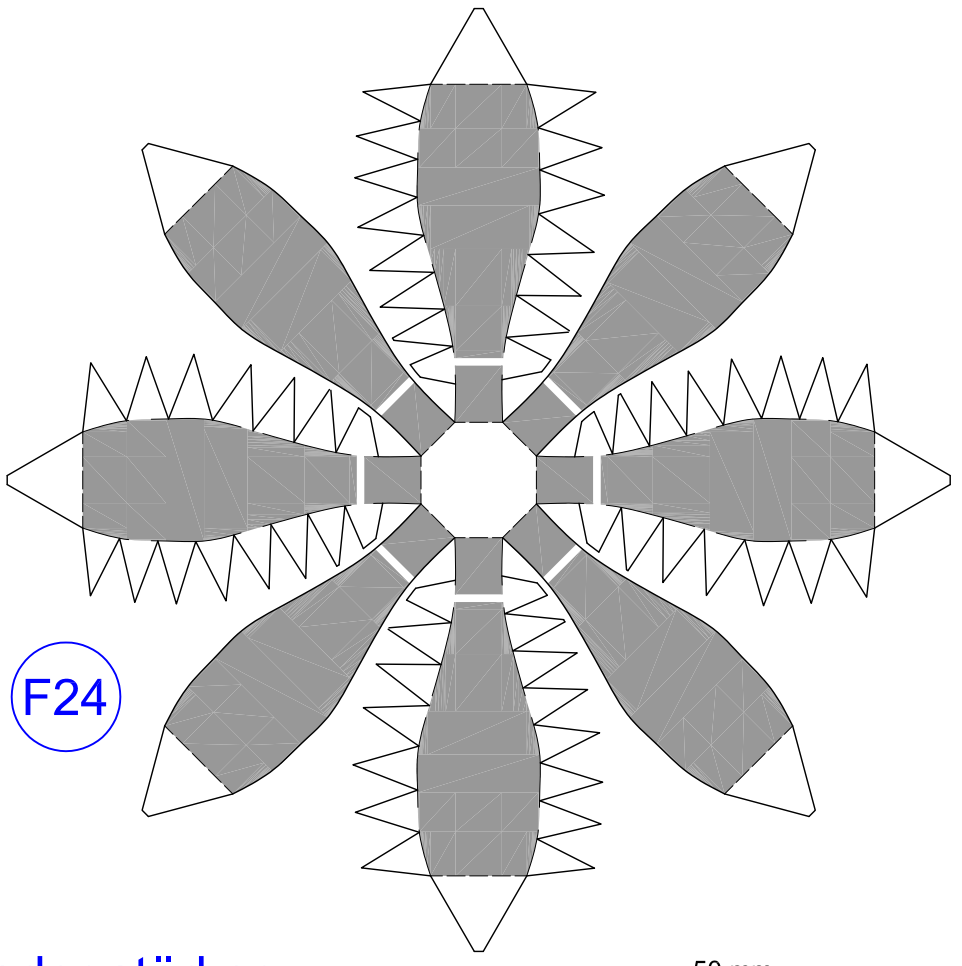

F24

Blatt 23/23 80 g/m<sup>2</sup> oder stärker

